

English

# AVANT<sup>®</sup>

## 218/220

### Operator's Manual 2013-



# TABLE OF CONTENTS

**INTRODUCTION .....3**

**AVANT 200 SERIES WARRANTY .....3**

**EC DECLARATION OF CONFORMITY .....4**

**HOW TO WORK SAFELY ..... 5**

**DECAL LOCATIONS .....6**

**MAIN PARTS OF THE LOADER.....7**

**TECHNICAL SPECIFICATION .....8**

**LOAD DIAGRAM .....9**

**CONTROLS .....10**

**LOCATION OF BATTERY DISCONNECT SWITCH .....12**

**STARTING THE ENGINE.....12**

**STOPPING THE ENGINE .....12**

**DRIVE CONTROL.....13**

**FUNCTION OF DRIVE PEDALS .....13**

**STEERING OF THE MACHINE .....14**

**LOADER CONTROL.....14**

**USING THE AUXILIARY HYDRAULICS.....14**

**HAND THROTTLE .....14**

**COUPLING THE ATTACHMENTS .....15**

**MAINTENANCE SCHEDULE .....16**

**MOUNTING OF THE SERVICE SUPPORT .....16**

**SAFETY INSTRUCTIONS FOR MAINTENANCE .....17**

**SAFETY INSTRUCTIONS WHEN HANDLING THE BATTERY .....17**

**TRANSPORTING AND LIFTING .....17**

**MAINTENANCE INSTRUCTIONS.....18**

**FILTER LOCATION.....20**

**GREASING POINTS .....20**

**REFUELING.....21**

**DRIVE BELT .....21**

**HYDRAULIC SYSTEM.....22**

**ELECTRICAL HARNESS.....22**

**TROUBLESHOOTING .....23**

**SERVICES MADE .....23**

## **INTRODUCTION**

**AVANT** Tecno Oy wants to thank you for purchasing this **AVANT** loader. It is the result of Avant's long experience in design and manufacturing of compact loaders.

We ask you that you read and understand the contents of this manual completely before operating the loader. This will improve your operating and maintenance efficiency, help avoid breakdowns and damage and extend your machine's life.

Contact your local **AVANT** dealer for advice regarding service, parts and any problems relating to the operation of your **AVANT**.

## **AVANT 200 SERIES WARRANTY**

This warranty specifically applies to the **AVANT** 200 series loaders only and not to any attachments used with this product.

Any repairs or modifications performed without the prior authorisation of **AVANT** Tecno Oy will cancel this warranty.

During the first year of operation or first 500 hours (whichever is the soonest) **AVANT** Tecno Oy warrants to replace any part or repair any defect which may occur, subject to the terms detailed below:

- 1) The product has received regular maintenance in accordance with schedules given by the manufacturer.
- 2) Any damage caused by operation in a negligent manner or exceeding the approved specifications detailed in this manual is excluded.
- 3) **AVANT** Tecno Oy accepts no responsibility for interruption to working or any other consequential losses resulting from any failure of the product.
- 4) Only **AVANT** Tecno Oy approved replacement or original quality parts shall be used during routine maintenance.
- 5) Any damage caused by the use of incorrect fuel, lubricants, cooling liquid or cleaning solvents is excluded.
- 6) The Avant Warranty excludes any consumable parts (e.g. tyres, spark plugs, batteries, filters, belts etc.) except where it can be clearly shown that these parts were defective on original supply.
- 7) Any damage caused resulting from the use of attachments not approved for use with this product is excluded.
- 8) In the event a fault occurs which is attributable to manufacturing or assembly defect you should arrange to return your **AVANT** to your authorised dealer for repair. Travel and freight cost are excluded.

Engine warranty: Engines are warranted by the engine manufacturer (Kohler). Warranty conditions for the engine can be found in the warranty note for Kohler engines and in the Operating Manual for Kohler engines, delivered with the loader.

## **IDENTIFICATION OF THE LOADER**

Write down the following information about your loader, it will help you when ordering parts etc.

1. Model: **AVANT** \_\_\_\_\_ Purchase date: \_\_\_\_\_
2. Serial number: \_\_\_\_\_
3. Engine serial number: \_\_\_\_\_

The serial number and model of the loader are printed on the manufacturer's plate (decals no. 6, see page 6). Location of engine serial number can be found in the operating manual of the engine.

**EC DECLARATION OF CONFORMITY**

- 1. Manufacturer: **Avant Tecno Oy**
- 2. Address: **Ylötie 1  
FI-33470 YLÖJÄRVI  
FINLAND**
- 3. Technical Construction File Location: **Same as Manufacturer**
- 4. **We hereby declare that the machines listed below conform to EC Directives: 2006/42/EC (Machinery), 2004/108/EEC (EMC) and 2000/14/EC (Noise Emission).**
- 5. Category: **EARTH-MOVING MACHINERY/LOADERS/COMPACT**
- 6. Model: **AVANT** \_\_\_\_\_
- 7. Serial Number: \_\_\_\_\_
- 8. Year of Manufacture: \_\_\_\_\_

9. Directive / Conformity Assessment Procedure / Notified Body:

<b>2006/42/EC</b>	<b>Self-certification</b>	-----
<b>2004/108/EEC</b>	<b>Self-certification</b>	-----
<b>2000/14/EC</b>	<b>Type-test</b>	<b>MTT Agricultural Engineering Research (VAKOLA) Vakolantie 55, 03400 Vihti, FINLAND</b>

- 10. Name: **Risto Käkelä**
- 11. Position/Title: **Managing Director**
- 12. (Signature)  \_\_\_\_\_
- 13. Place: **Ylöjärvi, Finland**
- 14. Date: \_\_\_\_\_

## HOW TO WORK SAFELY

An incorrect or careless operation of the loader may be the origin of a serious accident. Before putting the machine into operation, familiarise yourself with the use of the machine and read and understand this Operator's Manual as well as the safety instructions.

### THIS SYMBOL INDICATES THE IMPORTANT SAFETY FACTORS.



































Understand the limitations of speed, braking, steering and stability as well as loading capacity of the machine before starting operation. Make sure that every one who operates or works with this equipment is familiar with these safety precautions.

The loader must only be used for the tasks and with the attachments approved by the manufacturer.

If you have no previous experience of the machine, make sure to do all testing at a safe and open place with no persons in the area of operation.

## SAFETY INSTRUCTIONS

-  Never use the loader without instructions. Read loader signs (decals), and this manual.
-  Start the operation slowly and carefully.
-  Do not wear loose clothing, long uncovered hair or jewelry near machine.
-  When driving be comfortably seated in the driver's seat, keep your feet in their proper place in the footwell and at least one hand on the steering wheel.
-  Operate the control levers and the lever of auxiliary hydraulics only when sitting in the driver's seat.
-  Operate the control levers with ease and without hesitation.
-  When coupling the attachment, make sure that the locking pin locks in positively.
-  Never put any part of the body or let anyone go under the lifted boom.
-  Do not transport persons in the bucket. The machine is not designed to lift or to transport persons.
-  Keep hands, feet and clothing away from any moving part and/or hydraulic cylinder.
-  Never carry passengers. Keep other bystanders away from the work area.
-  Drive slowly on uneven terrains. Watch out for ditches, manholes and steep gradients.
-  Do not drive on too steep a gradient. Load, unload, and turn on flat level ground.
-  Make sure that the ventilation is sufficient when working indoors or otherwise confined area.

-  Do not use loader in an atmosphere with explosive dust or gases or where exhaust can contact flammable material, explosion or fire can result.
-  **Do not transport the load with the boom lifted.** Always carry bucket or attachment as low as possible, and put the load down whenever you leave the machine.
-  When lifting or lowering the load, do not operate the boom control lever abruptly. Turn the lever smoothly and with care.
-  Do not exceed rated operating capacity - follow the load diagrams.
-  Do not park the machine on a surface with a gradient. Should this be necessary, use the parking brake and preferably turn the machine sideways and put down the bucket. If needed, use chocks behind the wheels.
-  Before leaving driver's seat:
  - Lower the loader boom
  - Place attachment flat on ground
  - Stop the engine, remove the key
  - Engage the parking brake
-  Never perform any maintenance or repair operation when the engine is running.
-  Stop and cool the engine before adding fuel.
-  Keep the engine area clean of flammable materials.
-  Wear eye protection when servicing, and hard hat or other protective equipment as needed.
-  When connecting a booster battery for "jump" start, always make last connection (negative cable) to engine, never at battery. When removing the "jump" start cable, always remove the negative cable (-) from engine first.
-  Never charge a frozen battery.
-  Lead acid batteries produce flammable and explosive gases. Keep arcs, sparks, flames and lighted tobacco away from battery.
-  Battery acid causes severe burns. In case of acid contact, wash immediately with water for several minutes and get medical attention in case of eye contact.
-  Use a piece of cardboard to check for hydraulic leaks. Leaking fluids under pressure can enter the skin and cause serious injury. Medical attention is required if hydraulic or other fluids contact skin.
-  Never modify the loader or add attachments not approved by **AVANT Tecno Oy**.
-  Do not smoke during refueling or driving.
-  If the loader is transported e.g. on a trailer, make sure that the articulation joint is securely locked by fitting the frame lock (painted red, see p. 17) on the left side. Ensure it is removed before commencing driving again.
-  When turning with the loader, keep in mind that the chassis extends beyond the turning radius of the wheels (collision risk).
-  Read this Operator's Manual carefully, especially if you are unfamiliar with the safe use and operation of the machine.

## DECAL LOCATIONS

If any of these decals has been removed or is unreadable it should be replaced without delay.

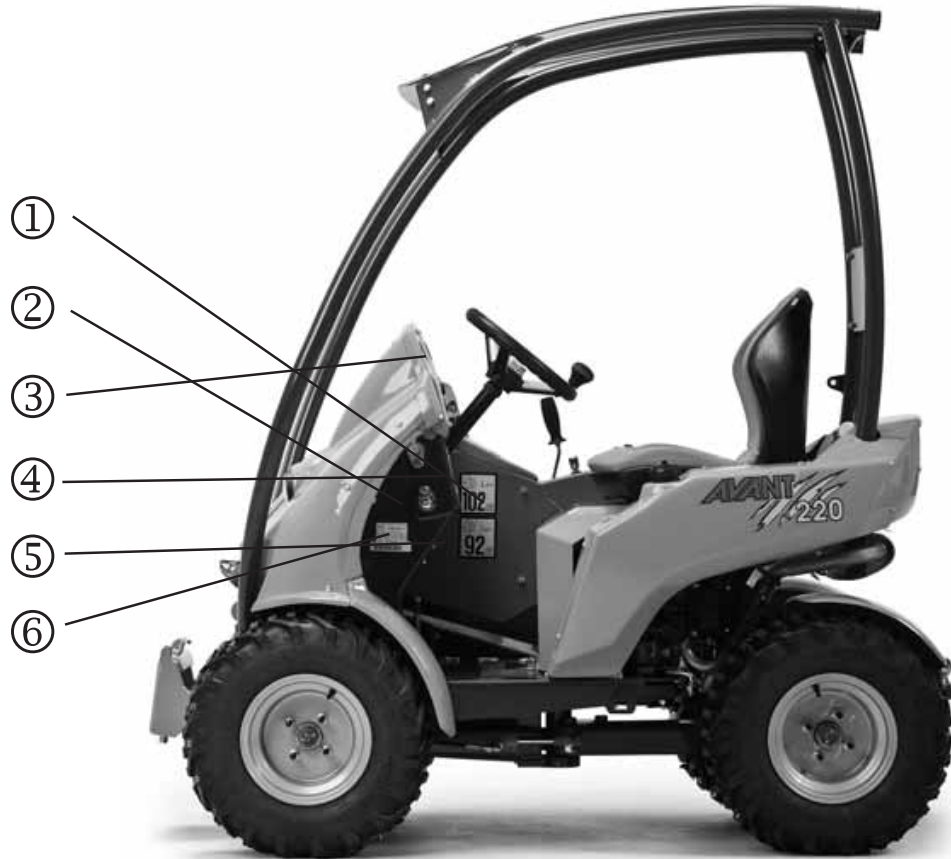

①

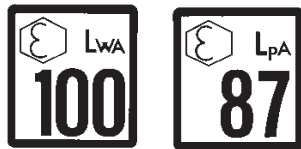

④



②



⑤



③



⑥



## MAIN PARTS OF THE LOADER

Following picture shows the main parts of the loader:



### ① Front frame

Front frame is the part of the loader in front of the articulation joint. On the front frame are mounted: driver's seat, operating controls, engine with accessories, hydraulic pumps, hydraulic control valves, hydraulic oil tank, fuel tank, auxiliary hydraulics outlet, front wheels, hydraulic motors and the loader boom with attachment coupling plate.

### ② Back frame

Back frame is the part of the loader behind the articulation joint. On the back frame are mounted: rear wheels, hydraulic motors, counterweights, trailer coupling.

### ③ Articulation joint

Articulation joint connects the front and back frame. The loader is steered hydraulically by the steering cylinder which is mounted between the front and back frames.

### ④ Loader boom

Loader boom is mounted on the front frame with two pivot pins. The attachment coupling plate is mounted on the lower end of the boom. Loader boom is equipped with a self leveling system: It keeps the bottom of the attachment (e.g. bucket, pallet fork) level when the boom is being lifted or lowered. Tilt movement can be adjusted with control lever no. 7 (see page 11).

### ⑤ Attachment coupling plate

Attachments are mounted on the attachment coupling plate. Attachment is the equipment with which the work is being performed (e.g. bucket, pallet fork, rotary broom etc.).

### ⑥ Auxiliary hydraulics outlet

The hydraulic hoses of hydraulically operated attachments are mounted on this outlet with quick couplers. The outlet is double acting: it has two pressure lines and one return line.

## TECHNICAL SPECIFICATION

Model	AVANT 218/220
Length	1745 mm
Width	960 mm
Height	1856 mm
Ground clearance	170 mm
Weight	590/620 kg
Standard tyres	20x8.00-10"Grass / 21x8.00-10"TR
Drive speed	0 - 10 km/h
Drive hydraulics	hydrostatic
Hydraulic oil tank capacity	23 l
Auxiliary hydraulics	AVANT 216: 23 l/min 185 bar AVANT 220: 29 l/min 185 bar
Steering wheel rounds left / right	1,8 / 2,4
Turning radius inside / outside	850 / 2100 mm
Lifting height	1470 mm
Max. pulling force	600 daN
Max. lifting capacity (hydr.)	350 kg

Model	AVANT 218	AVANT 220
Engine type	Kohler CV620	Kohler CV640
Function	4 stroke	4 stroke
Cooling system	air	air
Number of cylinders	2	2
Starter	electric	electric
Bore * stroke	77 * 67 mm	77 * 67 mm
Displacement	624 cm <sup>3</sup>	624 cm <sup>3</sup>
Max. output	13,4 kW (18 hv)	14,9 kW (20 hp)
Fuel	petrol min. 92 oct.	petrol min. 92 oct.
Fuel tank capacity	9 l	9 l
Engine oil capacity	2,0 l	2,0 l
Engine oil type	API CF-4/SG	API CF-4/SG
Viscosity	SAE 10W-30	SAE 10W-30
Valve clearance, suction	0,08 mm	0,08 mm
Valve clearance, exhaust	0,09 mm	0,09 mm
Sound pressure level L <sub>PA</sub>	89 dB (A)	89 dB (A)
Sound output level L <sub>WA</sub>	102 dB (A)	102 dB (A)

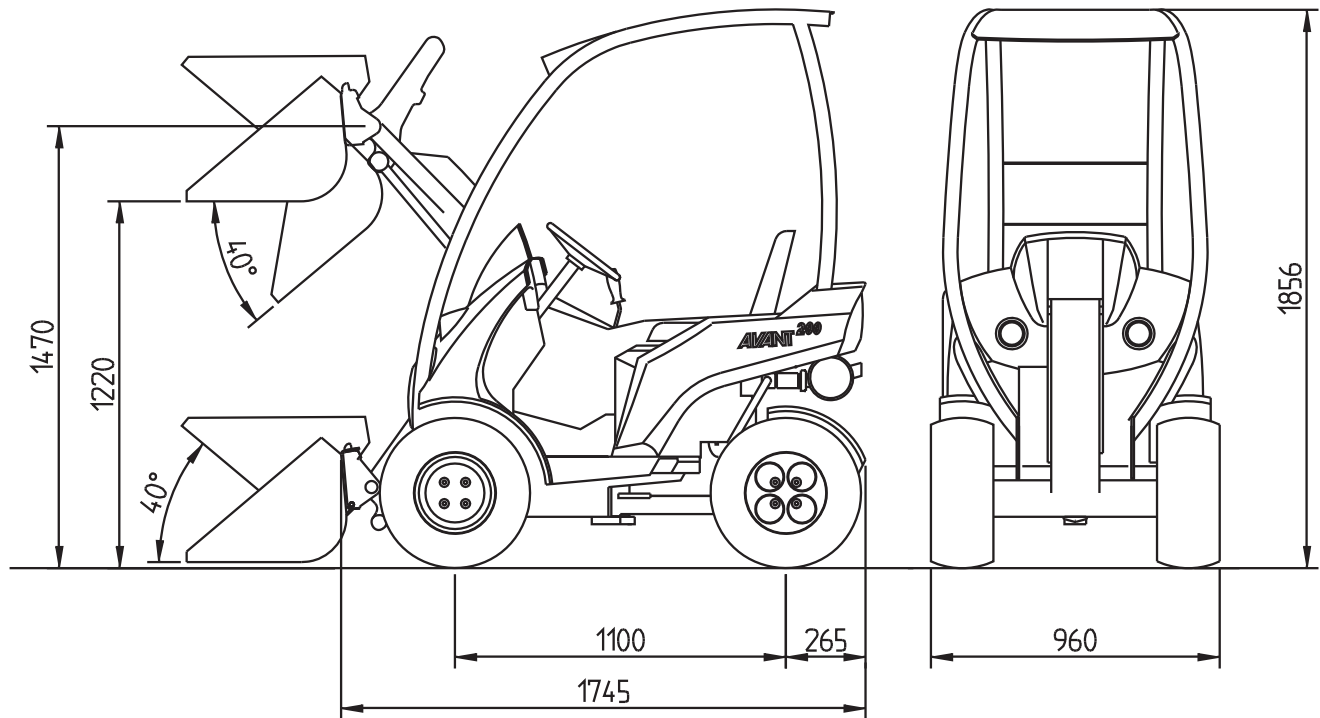



## LOAD DIAGRAM

The lifting capacity of the loader is limited by the possibility of tipping around the front axle. The diagram below shows the tipping loads and max. allowed loads in different loading situations on an even level surface with the loader in maximum articulation (i.e. minimum restoring moment).

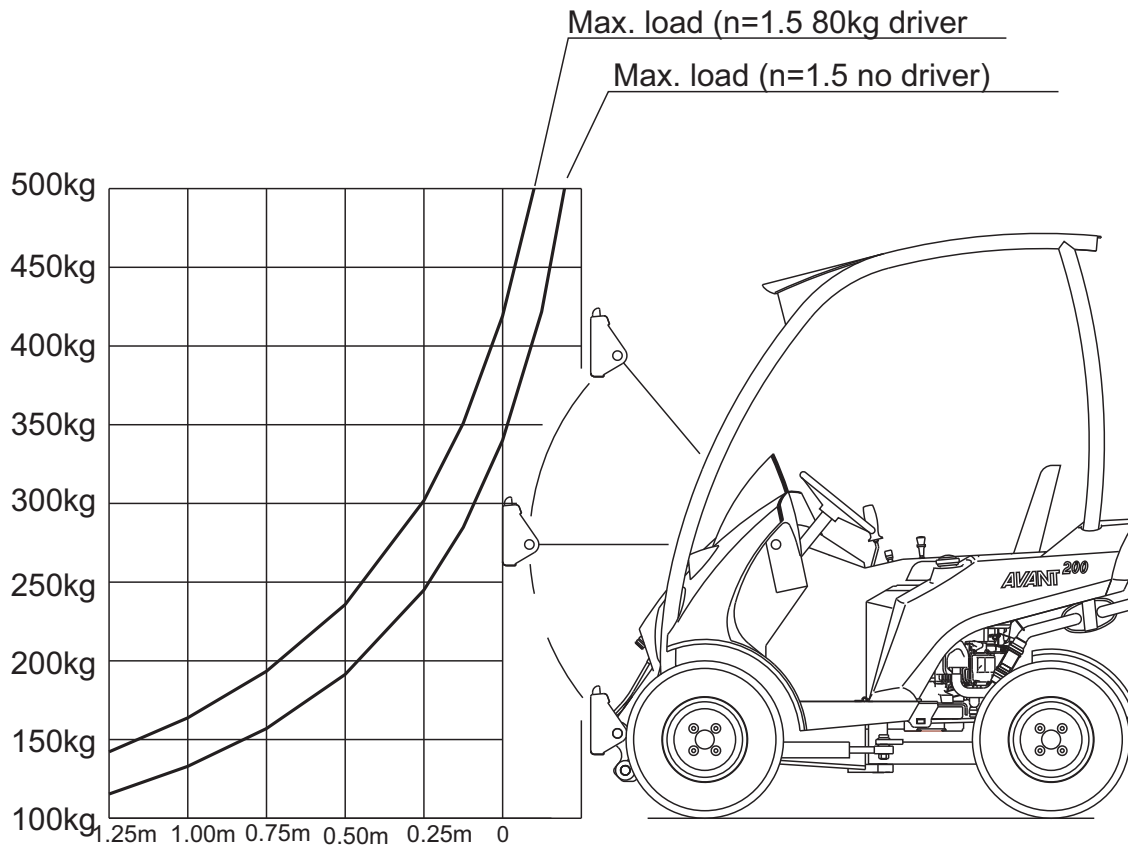

**AVANT 200 series Load diagram**

The diagram can be interpreted as follows:

- The diagrams show max. loads with the boom in different positions and with the load at different distances from the attachment coupling plate
- Max. load should be reduced when the load is farther away from the attachment coupling plate
- If the center of gravity of the load is 50 cm in front of the attachment coupling plate, max. load is 230 kg with a driver weighing 80 kg and with a safety factor of 1,5 against tipping over (n=1,5)
- With the load carried at low level max. load of 300 kg can be transported at the above mentioned case
- Please note that the diagrams are based on the machine operating on a level, even and firm supporting ground. Loads should be significantly reduced when operating on gradients and/or on soft ground.



**ALWAYS KEEP AND TRANSPORT THE LOAD AS CLOSE TO THE GROUND AS POSSIBLE**



**NEVER TAKE A HEAVY LOAD ON THE LOADER FROM HIGH LEVEL - E.G. FROM TRUCK, SHELF ETC. - RISK OF TIPPING OVER!**



**ALWAYS PUT DOWN THE LOAD BEFORE LEAVING THE MACHINE**

## OPERATING CONTROLS

Following picture shows the location of operating controls. The location and function of controls may be slightly different in different models, see following pages.



- |    |                                  |     |   |
|----|----------------------------------|-----|---|
| 1. | Steering wheel                   | 10. | Choke                                       |
| 2. | Hour meter                       | 11. | Drive pedal, right: drive forward           |
| 3. | Ignition switch                  | 12. | Drive pedal, left: drive backward           |
| 4. | Signal horn                      | 13. | Parking brake handle                        |
| 5. | Light switch                     | 14. | Lockable auxiliary hydraulics control pedal |
| 6. | Fuse box                         | 15. | Oil temperature gauge (optional extra)      |
| 7. | Control lever of boom and bucket | 16. | Drive circuit release valve                 |
| 8. | 12 V outlet                      | 17. | Work light indicator                        |
| 9. | Hand throttle lever              |     |   |

## CONTROL OF LOADER BOOM, ATTACHMENTS AND OTHER FUNCTIONS

Most of the functions of the loader are controlled at the control panel on the right side of the operator: Boom and bucket movements, engine revs etc.. Following pictures show the different functions:

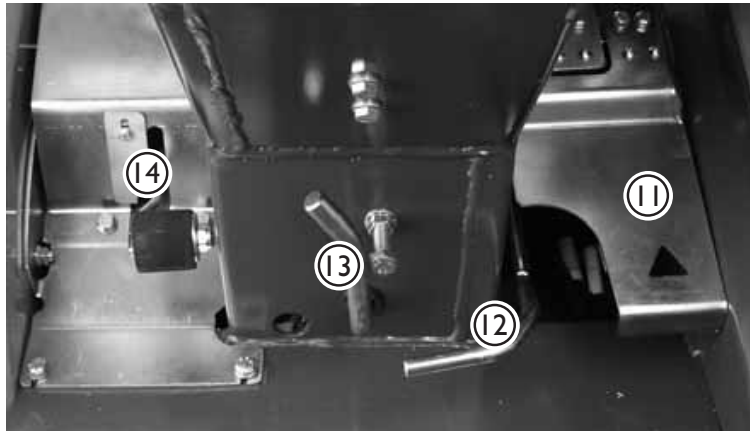

- 7. Control lever of boom and bucket**
  - Pull backward to lift the boom
  - Push forward to lower the boom
  - Push left to raise the tip of the bucket (filling)
  - Push right to lower the tip of the bucket (emptying)
- 9. Hand throttle lever**
  - Push forward to increase engine revs
  - Pull backward to reduce engine revs
- 10. Choke**
  - Lift up the knob to increase the choke
  - Push down the knob to reduce choke
- 11. Drive pedal, right:** drive forward
- 12. Drive pedal, left:** drive backward
- 13. Parking brake handle**
  - locking: turn left and down into locking position
  - releasing: turn right and up to release parking brake, if necessary make a sharp turn with the steering wheel so that the locking pins unlock in the front wheels
- 14. Control pedal of auxiliary hydraulics (hydraulically operated attachments)**
  - Lift the pedal carefully to test the operating direction of the attachment
  - Press + turn left to locking position: the attachment operates in reversed direction
- 17. Drive circuit release valve**
  - In normal operation ("unlock" selected) hydraulic oil flows in series from motor to motor. When turning the knob counterclockwise the hydraulic oil flow is gradually diverted, and in "lock" position oil flows parallel between the hydraulic motors on each side, similar to a parallel differential lock in operation.

## LOCATION OF BATTERY DISCONNECT SWITCH

All AVANT loaders are equipped with a battery disconnect switch. In AVANT 218/220 the switch is located under the drivers seat in engine compartment. Following pictures show the location of this switch.

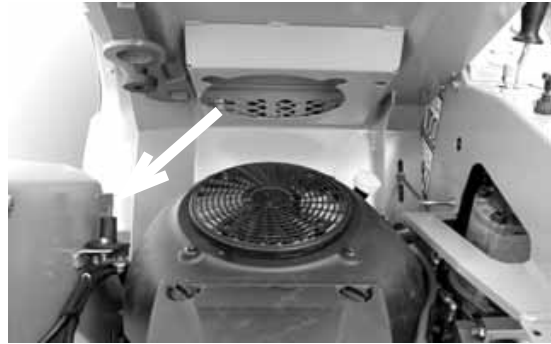

## STARTING THE ENGINE



(see also KOHLER Owner's Manual)

- Turn the battery disconnect switch to ON



- Adjust the throttle lever to 1/4. 9
- Lift up the choke button 10
- **NOTE: Do not use the choke if the engine is warm or the air temperature is high**



- Turn the ignition key to the right until engine starts, then let the key return to ON position 3
- Reduce choke (push choke button down) as soon as engine has started, push completely down when engine has warmed up



**THE ENGINE CANNOT START IF THE AUXILIARY HYDRAULICS CONTROL PEDAL IS IN LOCKING POSITION.**

## STOPPING THE ENGINE

- Turn the ignition key to the OFF position (to the left)
- Turn the power off with the battery disconnect switch

### DRIVE CONTROL



**AVANT 200** series loaders are equipped with a hydrostatic drive system, there is a variable displacement hydraulic pump in the drive circuit. The oil flow of this drive pump is steplessly adjusted with the two drive pedals. The drive pedals act in a proportional way to control the drive speed and power available at the drive motors.

This hydrostatic drive system has different operating characteristics to a mechanical drive. To get maximum pushing power push the pedals lightly - for higher travel speed push the pedal harder.

Driving of the machine is **controlled with the drive pedals** as follows:

Select the revs of the engine with the **hand throttle lever** on the control panel. The basic rule is: use lower revs for lighter work and higher revs for hard work.



If you want to **drive forward**, press gently on the **right** drive pedal until the machine starts to move slowly. The desired drive speed is selected with the drive pedal: the more the pedal is pressed the faster you will travel.

When you **wish to stop** gently release the pedal by lifting of your foot, and the machine will slow and stop.

**Drive backward** is controlled with the **left** drive pedal in the same way as drive forward: the more the pedal is pressed the faster you will travel.

When you have learned how to drive on low speed, increase speed gradually and learn how to drive with higher drive speeds.

### FUNCTION OF DRIVE PEDALS



When thinking about the function of the two drive pedals, they should be compared to gears, not to a conventional throttle pedal. The **drive pedal** in a way **shifts on a higher gear** the more the pedal is pressed. Therefore you shouldn't press the pedal more when the engine starts to struggle. Pressing the pedal just causes the engine to stop.

**When you want to have a high pulling force:**

1. Use high engine revs
2. Select a relatively slow drive speed with the drive pedal. That is: press the pedal only lightly (= select a low gear). This way the full output of the hydraulic system and the engine can be taken out.

## STEERING OF THE MACHINE

Steering of the machine is actuated via the steering wheel. The steering wheel is hydraulically powered. A practical way of steering is to steer with your left hand on the knob of the steering wheel. This way your right hand is free to operate other functions. Familiarise yourself with the special drive features and space needs of this articulated loader on a flat, even and open place. Remember that, when turning, the front frame of the loader extends beyond the turning radius of the wheels.

### **NEVER TIP OVER THE LOADER. NEVER USE A HIGH DRIVE SPEED WHEN TURNING.**



In particular: when the loader boom is up the stability of the machine is much weaker when turning.

**WHEN DRIVING, ALWAYS KEEP THE LOADER BOOM AS LOW AS POSSIBLE.** Risk of tipping over increases considerably when there is a heavy load on the loader (a heavy attachment or a big load in the bucket) and the boom is up when driving.



**ALWAYS REMEMBER – SAFETY FIRST.**



**TEST ALL THE FUNCTIONS OF THE LOADER AT AN OPEN AND SAFE PLACE.**



**MAKE SURE THAT THERE ARE NO PERSONS IN THE OPERATING AREA OF THE MACHINE.**



## LOADER CONTROL

The loader boom and bucket are controlled with the multi-function lever sideways (tilt) and back & forward (boom up & down).



- Pull backward to lift the boom
- Push forward to lower the boom
- Push left to raise the tip of the bucket (filling)
- Push right to lower the tip of the bucket (emptying)

## USING THE AUXILIARY HYDRAULICS

Auxiliary hydraulics (hydraulically operated attachments) are controlled with the pedal no. 14 in the footwell.



Auxiliary hydraulics control pedal locks in the locking position (down left) which facilitates operation of the attachments that require constant oil flow (rotary broom, backhoe etc.).

**NOTICE! THE ENGINE CANNOT START IF THE AUXILIARY HYDRAULICS CONTROL PEDAL IS IN THE LOCKING POSITION.**



**THE OPERATING DIRECTION OF THE ATTACHMENT DEPENDS ON THE COUPLING OF THE ATTACHMENT HOSES. MAKE SURE THAT THERE ARE NO PERSONS IN THE DANGER AREA WHEN TESTING THE OPERATING DIRECTIONS. CHANGE THE COUPLING OF THE HOSES IF NECESSARY.**



## HAND THROTTLE



When driving, the revolution speed of the engine can be adjusted with the hand throttle lever, if necessary. Do not turn the machine with a high driving travel speed.

## COUPLING THE ATTACHMENTS

Coupling of the attachments into the attachment coupling plate happens as follows:



### Stage 1:

- Lift up the locking pin and turn it backward so that it remains in the locked up position.
- Make sure that the pin remains in the up position, otherwise you cannot couple the attachment properly!



### Stage 2:

- Turn the attachment coupling plate with the tilt movement so that the upper edge of the plate leans forward.
- Drive the loader into the attachment so that the pins in the upper left and right corner of the attachment coupling plate go into the holes of the attachment bracket.



### Stage 3:

- Lift the boom a little so that the attachment lifts off of the ground.
- Pull the boom control lever to the left so that the lower edge of the attachment coupling plate turns into the attachment.



### Stage 4:

- Pull the boom control lever more to the left so that attachment coupling plate turns more and the boom pushes the pin down in the hole of the attachment.
- **CAUTION! Make sure that the pin locks properly down in the hole of the attachment.**



### Stage 5:

- If the attachment is equipped with hydraulic hoses, make sure to connect the hoses in the quick couplings on the loader.
- Engine must be stopped when connecting the hoses. Before connecting the hoses move the auxiliary hydraulics control lever in both directions a couple of times in order to release eventual back pressure.
- Additional information about the coupling is provided in the instruction manual of the attachment.
- **NOTICE! When fitting an attachment, make sure that the hydraulic hoses are not overstretched and are not in a position where they can be trapped during the operation of the machine and attachment.**

## MAINTENANCE SCHEDULE

Following table shows the maintenance and service points and intervals. There are more detailed instructions about each service operation, in numerical order, on the following pages.

<b>LOADER</b>	Every day	Every week	After 25 h	After 50 h	Every 100 h	Every 200 h	Every 400 h	Every 500 h	Every 800 h	Every 1000 h	Every year
1. Clean the machine	■										
2. Check tyre pressure		●									
3. Check battery electrolyte level		●									
4. Check hydraulic oil level		●									
5. Change hydraulic oil filters				●		●					
6. Change hydraulic oil				●			●				
7. Check tightness of bolts, nuts and hydraulic fittings			●								
8. Check pressure of hydraulic system				■							●
9. Adjust pressure of hydraulic system				■							■
10. Grease the machine	■	●									
<b>ENGINE*)</b>											
11. Check engine oil level		●									
12. Change engine oil					●						
13. Clean air filter	■	●									
14. Clean fuel filter and sediment cup					●						
15. Clean spark arrester					●						
16. Change spark plug					●						
17. Change engine oil filter						●					
18. Change air cleaner element											●
19. Check and adjust valve clearances											●

● Maintenance operation

■ When necessary

\*) More specific engine maintenance instructions can be found in the owner's manual of the engine, supplied with the loader.

## MOUNTING OF THE SERVICE SUPPORT

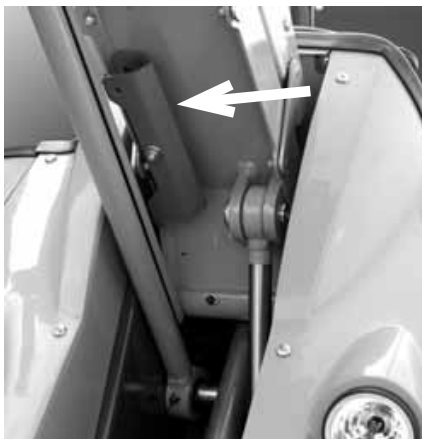

Always secure the lifting boom with the service support whenever working under it. Make sure that the boom stays up by putting the service support on the lift cylinder piston rod.

The red service support is located under the boom and fastened with a bolt

Make sure to secure the service support by locking it on the piston rod by the bolt





## SAFETY INSTRUCTIONS FOR MAINTENANCE



- ALWAYS REMEMBER SAFETY DURING MAINTENANCE
- DO NOT PERFORM ANY SERVICE OPERATION WHEN THE ENGINE IS RUNNING
- USE THE SERVICE SUPPORT ON THE BOOM CYLINDER
- DO NOT GO UNDER UNSUPPORTED BOOM
- DO NOT SMOKE DURING SERVICE OPERATIONS
- BEWARE POSSIBLE HIGH PRESSURE IN HYDRAULIC CIRCUITS

## SAFETY INSTRUCTIONS WHEN HANDLING THE BATTERY



- BATTERY CONTAINS CORROSIVE SULFURIC ACID.
- AVOID CONTACT WITH SKIN OR CLOTHES. IF ELECTROLYTE GETS ON YOUR SKIN OR CLOTHES, FLUSH WITH A LOT OF WATER.
- IN CASE OF CONTACT WITH EYES, FLUSH WITH A LOT OF WATER FOR AT LEAST 15 MINUTES AND CALL A DOCTOR IMMEDIATELY.
- WHEN CHARGING THE BATTERY GIVES OFF POTENTIALLY EXPLOSIVE GASES – DO NOT SMOKE WHEN HANDLING THE BATTERY.
- IN ORDER TO AVOID SPARK EMISSIONS ALWAYS DISCONNECT THE NEGATIVE (-) CABLE FIRST AND CONNECT IT LAST.
- BEFORE CONNECTING THE BATTERY CABLES MAKE SURE THAT THE POLARITY IS CORRECT: FAULTY CONNECTION WILL SERIOUSLY DAMAGE THE ELECTRIC SYSTEM OF THE ENGINE.

## TRANSPORTING AND LIFTING

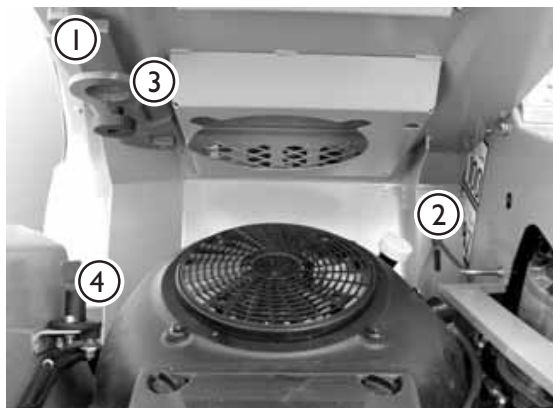

Following safety devices are located under the operator seat:

- 1. Frame lock:** The frame of the loader can be locked with the red frame lock.
- 2. Seat locking rod:** Keeps the seat in upright position when working in the engine compartment.

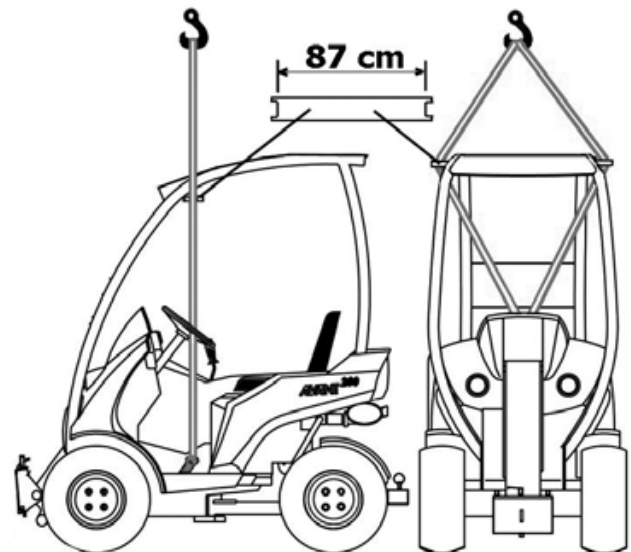

- 3. Lifting hook:** Must be installed in the floor plate when lifting the loader. Lifting sling must be conducted through the steering wheel. Attach a slotted bar under the canopy, which supports the sling at a distance at least 87 cm wide (make sure the sling is strong enough). This protects the canopy from damaging.
- 4. Battery disconnect switch:** Switches off the power supply from battery.

## 1. CLEANING OF THE LOADER

Cleanliness of the loader is not only a question of outer appearance. All surfaces, painted and others, will stay in better condition when they are cleaned regularly. A clean machine also lasts longer. A dirty machine will run hotter and will collect dirt into the air cleaner, which is likely to damage the engine. Pay special attention to the cleanliness of the engine, the oil tank cover, the engine compartment and the hydraulic pump compartment. The loader can be washed with a pressure washer.

**ATTENTION!** the loader is equipped with a hydraulic oil cooler, which is located behind the driver's seat, make sure to clean the oil cooler cell with compressed air every time you are servicing the loader - and even more frequently if the loader is being used in dusty conditions.

## 2. TYRE PRESSURE

Correct tyre pressure means that the tyres last much longer. Wrong tyre pressure increases tyre wear and can be a safety risk when working with the loader. Recommended tyre pressure is 2.3 bar (33.4 PSI).

## 3. BATTERY CHECK

In order to secure the starting and safe operation the battery of the loader must be checked regularly. Checking the electrolyte level of the battery happens by opening the filler caps. **ATTENTION!** Clean the battery before opening the caps so that dirt cannot get in the battery. Check also the contacts and clean if necessary.



## 4. HYDRAULIC OIL LEVEL

Hydraulic oil level can be checked with the dipstick in the filler. Oil level should be between the two marks in the dipstick. Refill when necessary. Clean the area before checking hydraulic oil level. Do not let any contaminants enter the hydraulic tank during this procedure.



## 5. CHANGING OF HYDRAULIC OIL FILTERS

The hydraulic oil return filter is located on top of the hydraulic oil tank, under the right cover beside steering wheel. Take off the cover and replace the oil filter cartridge.

The hydraulic pressure filter is located under the right side cover beside the hydraulic pumps. When unscrewing the filter hold the screw in the housing with a 12 mm allen key and replace the filter.



## 6. HYDRAULIC OIL CHANGE

When changing hydraulic oil, the oil can be removed with a suction pump or by opening the drain plug on the right side of the front frame, behind the front wheel. In both cases it is important to clean the magnetic drain plug. Hydraulic oil tank capacity is 23 litres. Use ISO VG-46 certified mineral hydraulic oil (e.g. Shell Tellus TX oil). Use of synthetic hydraulic fluids is not permitted.



## 7. CHECK AND TIGHTENING OF BOLTS, NUTS AND FITTINGS

Check tightness of bolts, nuts and hydraulic fittings regularly. **ATTENTION! Tighten wheel nuts after first 5 operating hours. Check tightness of wheel nuts regularly. Wheel nuts shall first be tightened to 100 Nm diagonally opposite and finally tightened to 120 Nm.**

## 8. CHECK PRESSURE OF HYDRAULIC SYSTEM

Pressure checking points for different functions are as follows:

### **Boom movement:**

Pressure is checked from the manometer fitting, which is located under the right side cover, beside the main hydraulic valve.

Pressure is measured with full engine revs and loading the hydraulics in the movement end position of boom or attachment plate. The pressure setting is 185 bar.

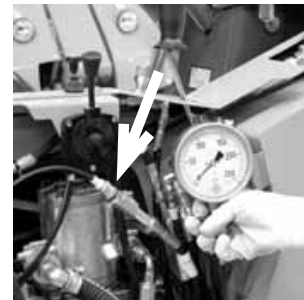

**Auxiliary hydraulics:** Pressure is checked by mounting the manometer in the female auxiliary hydraulics quick coupling, with full revs and by turning the aux. hydraulics control lever. The pressure setting is 185 bar.



**Drive pressure:** Can not be measured. If the pressures are clearly wrong one must change the pressure relief cartridges which have fixed pressure setting.

**It is recommended pressures should only be checked by a competent and experienced technician. Call your AVANT dealer if you need assistance.**

## 9. ADJUST PRESSURE OF HYDRAULIC SYSTEM

If the pressure of hydraulic system does not seem to be correct or pressure check indicates that the pressure is wrong, it can be adjusted. Following pictures show the pressure adjusting points.

**Boom movements:** Pressure is adjusted from the pressure relief valve at the main control valve. Pressure relief valve is the first section of the control valve, in front of the first valve segment. Adjust by turning the hexagonal head screw.



**Auxiliary hydraulics:** Pressure is adjusted from the pressure relief valve behind the left front wheel. Adjust by turning the hexagonal head screw.

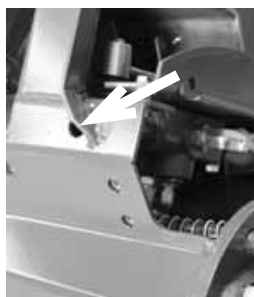

**Drive hydraulics:** Can not be adjusted. If the pressures are clearly wrong one must change the pressure relief cartridges which have fixed pressure setting.



**NEVER EXCEED THE RECOMMENDED HYDRAULIC PRESSURE SETTINGS. EXCESSIVE HYDRAULIC PRESSURE WILL DAMAGE THE HYDRAULIC PUMPS, CYLINDERS, AND HYDRAULIC MOTORS.**



**WARRANTY DOES NOT COVER DAMAGES CAUSED BY EXCESSIVE HYDRAULIC PRESSURE.**

## 10. GREASING OF THE MACHINE

Greasing of pivot points is very important in order to avoid wear. Most of the greasing points are on the loader boom. There are altogether 10 grease nipples on the loader. The pictures on page 20 shows the location of grease nipples.

## 11.-19. SERVICE, ENGINE

**AVANT 218** is equipped with the Kohler CV620 petrol engine. Service and maintenance instructions for this engine can be found in the Kohler Operator's Manual supplied with the loader.

**AVANT 220** is equipped with the Kohler CV640 petrol engine. Service and maintenance instructions for this engine can be found in the Kohler Operator's Manual supplied with the loader.

## 12. ENGINE OIL CHANGE



When changing the engine oil. Use the Oil line pictured above to drain out the old oil.

## FILTERS

Following pictures and tables show the location and part numbers for the filters.

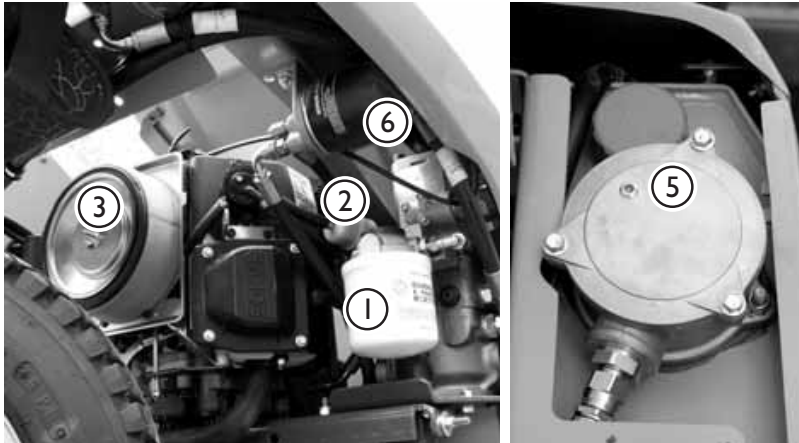

- 1. Hydraulic oil filter, pressure
- 2. Fuel filter
- 3. Air filter, element
- 4. Air filter, outer
- 5. Hydraulic oil filter, return
- 6. Engine oil filter

AVANT 218/220	
64825	Air filter, element
64826	Air filter, outer
74093	Hydr. oil filter, return
64807	Hydraulic oil filter, pressure
64827	Fuel filter
64824	Oil filter
A3958	Breather hydr. dipstick
64828	Spark plug

**A46683 218/220 Filter kit**

## GREASING POINTS

Following pictures show the location of greasing points.

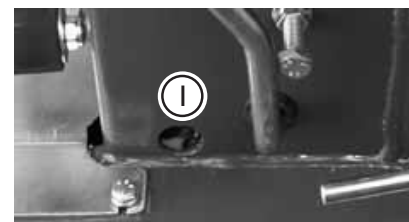
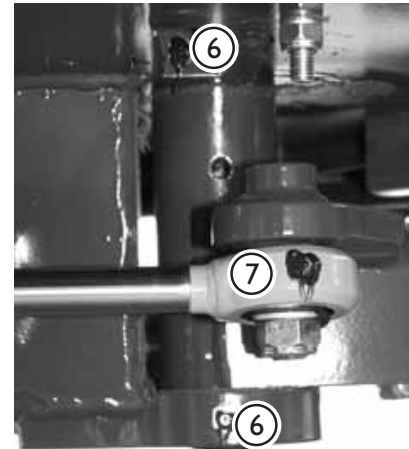
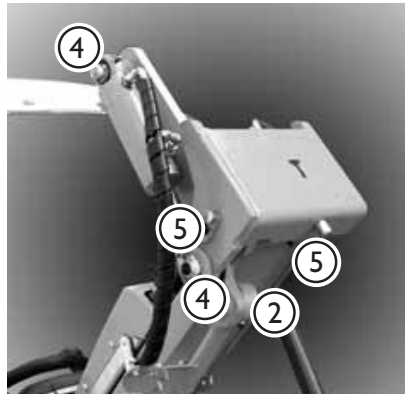
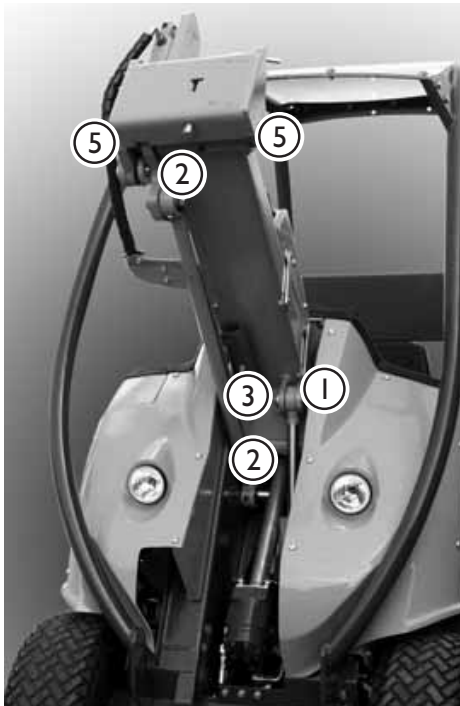

- 1. Lift cylinder, both ends
- 2. Self leveling bar, both ends
- 3. Pivot pins on loader boom
- 4. Tilt cylinder, both ends
- 5. Shot bolts and joint in attachment coupling plate
- 6. Articulation joint
- 7. Steering cylinder

## REFUELING

Check fuel level and fill the tank if necessary. Never use petrol mixed with oil or unclean petrol. Do not let dirt, dust or water get in the fuel tank. Make sure that the filler cap is properly tightened after refueling.



**DO NOT SPILL FUEL WHEN REFUELING. SHOULD THIS HAPPEN, WIPE THE FUEL AWAY IMMEDIATELY IN ORDER TO AVOID RISK OF FIRE.**



**ALWAYS STOP THE ENGINE BEFORE REFUELING. KEEP THE ENGINE AWAY FROM OPEN FIRE.**

## DRIVE BELT

**AVANT 218/220** is equipped with a drive belt which connects the hydraulic pump to the engine. The belt may get loose over a long period of time and may need tightening.

There is a hole in the bottom of the loader for checking the tightness of the drive belt. Belt is correctly tightened when it moves in the middle of the belt 9 mm when 70 N force is applied (look at the picture).

Belt tightening device increases tension of the drive belt (pulls the pump away from the engine) when the two screws on the right are being tightened. Loosening of these screws reduces tension of the drive belt.

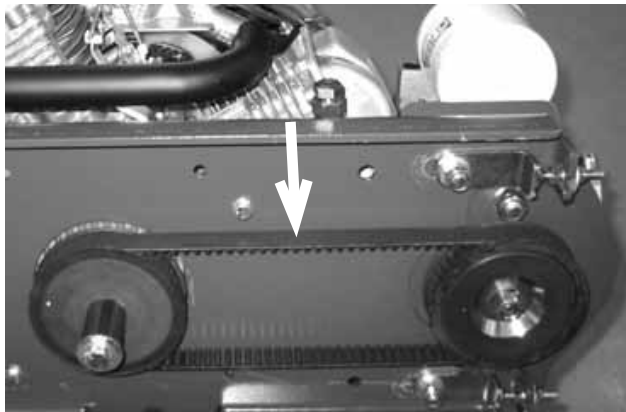

**ENGINE MUST BE STOPPED BEFORE CHECKING THE TIGHTNESS OF THE DRIVE BELT**



**IF THE BELT IS TOO TIGHT IT GIVES A WHISTLING NOISE. IN THIS CASE LOOSEN THE BELT AND CHECK AND ADJUST THE TIGHTNESS. LOOSEN THE BELT WITHOUT DELAY BECAUSE A STRETCHED OUT BELT CAN GET DAMAGED OR CAUSE DAMAGE TO THE HYDRAULIC PUMP**

## HYDRAULIC SYSTEM

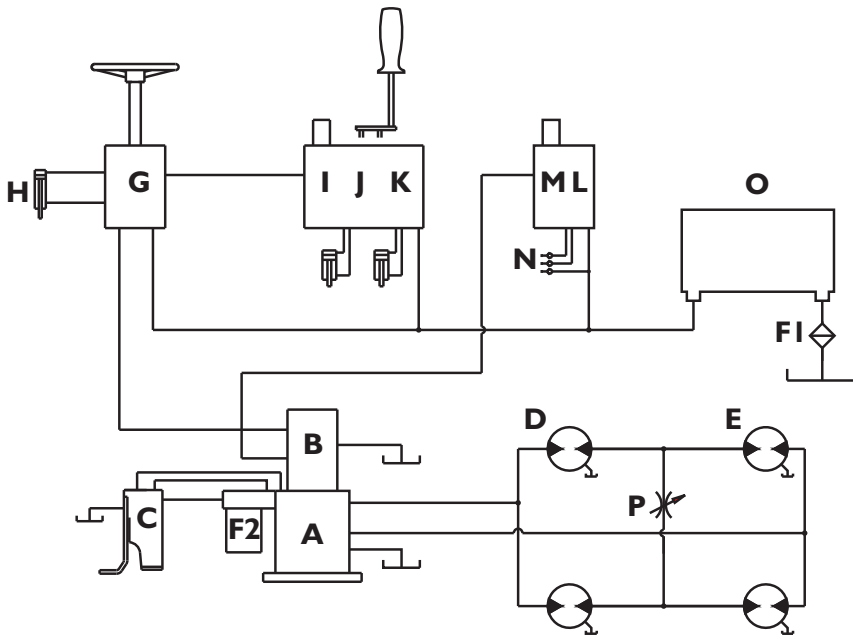

- A. Hydrostatic pump, with the feed pump
- B. Double gear pump
- C. Driving pedal valve
- D. Front wheels
- E. Rear wheels
- F. F1 -Hydraulic oil return line filter  
F2 -Hydraulic oil high pressure filter
- G. Orbit Roll steering valve
- H. Steering cylinder
- I. Gear pump 1. adjustment, pressure relief valve
- J. Boom lift cylinder control valve
- K. Bucket tilt cylinder control valve
- L. Gear pump 2. adjustment, pressure relief valve
- M. Control valve for the hydraulic outlet of the accessories
- N. Quick couplings of the hydraulic outlet
- O. Oil cooler
- P. Drive release valve

## ELECTRICAL HARNESS

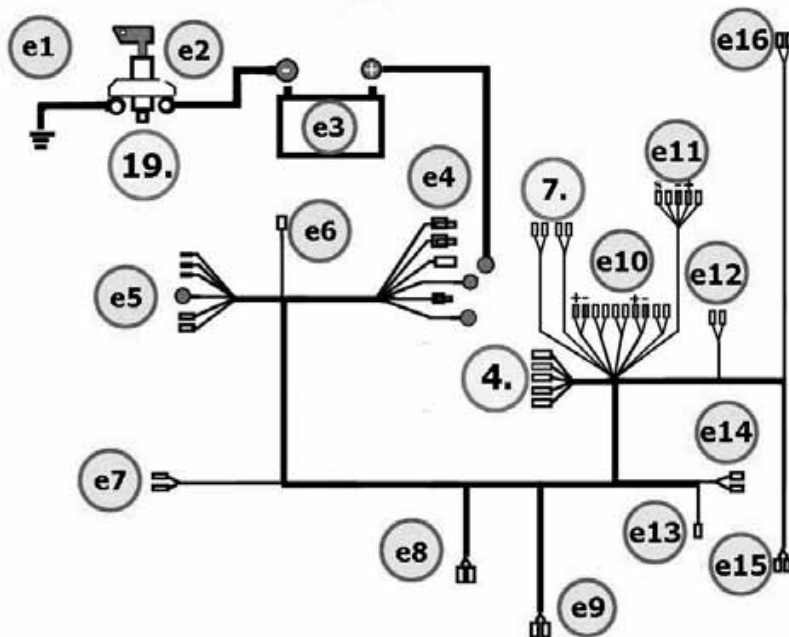

- e1. Earth cable
- 19. Electrical main switch
- e2. Grounding cable from battery
- e3. Battery 12 V
- e4. Starter motor
- e5. Regulator
- e6. Fuel stop valve
- e7. Oil cooler fan
- e8. Reverse beeper (optional)
- e9. Reverse switch (optional)
- 4. Ignition switch
- 7. Fuse box
- e10. Electric output, light switch, charge lamp, hour meter, horn button.
- e11. Optional temperature gauge
- e12. Horn
- e13. Temperature sensor
- e14. Thermostat switch for oil-cooler fan-motor
- e15. Working light
- e16. Working light

## TROUBLESHOOTING

Problem	Cause	Remedy
Hydraulic attachment does not work when the auxiliary hydraulics control lever is moved.	Attachment hoses are not coupled or they are coupled wrongly in the quick couplers.  Faulty or damaged quick couplers (will restrict or stop oil flow)	Make sure that the hoses are properly connected into the quick couplers, change the place of the hoses if necessary. Auxiliary hydraulics have double acting pressure couplers (female) and a return line (male coupler) Operating direction of the attachment depends on how the hoses are connected in the quick couplers.  Replace quick couplers.
Engine does not start.	No fuel  Auxiliary hydraulics control lever (lever no. 14, see pages 10 and 14) is in locking position.	Fill the tank.  Turn the lever in center (neutral) position.
Attachment hoses will not go into the quick couplers of the machine.	There is back pressure in the auxiliary hydraulics line.	Release the pressure by moving the auxiliary hydraulics control lever in both directions.
The machine moves after parking brake has been engaged.	The pins of the parking brake mechanism have not locked properly in the wheels.	Drive slowly forward or backward in order to lock the parking brake. When releasing the parking brake do this in opposite order.

## SERVICES MADE

Date	Operating hours	Remarks
1. _____	_____	_____
2. _____	_____	_____
3. _____	_____	_____
4. _____	_____	_____
5. _____	_____	_____



**AVANT**<sup>®</sup>  
**AVANT TECNO OY**

[www.avanttecno.com](http://www.avanttecno.com)

e-mail: [sales@avanttecno.com](mailto:sales@avanttecno.com)

Ylötie 1  
FIN-33470 YLÖJÄRVI  
FINLAND

Tel. +358 3 347 8800

Fax +358 3 348 5511

AVANT has a policy of continuing improvement, and retains the right to change specifications without notice.