

GB Operating instructions

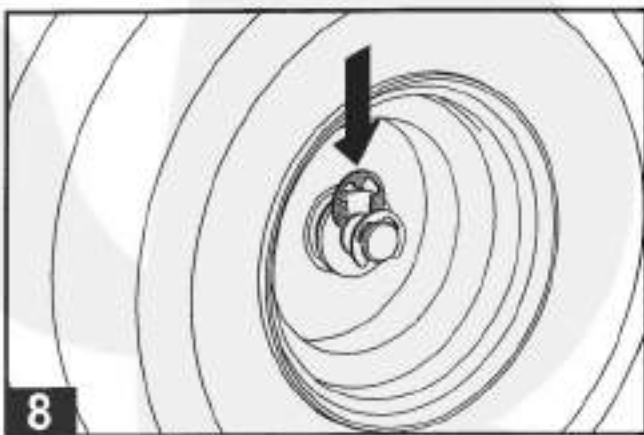

461 813

abc def
2006

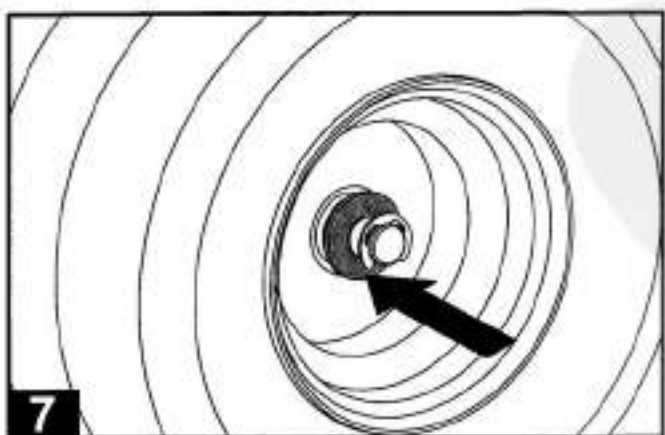
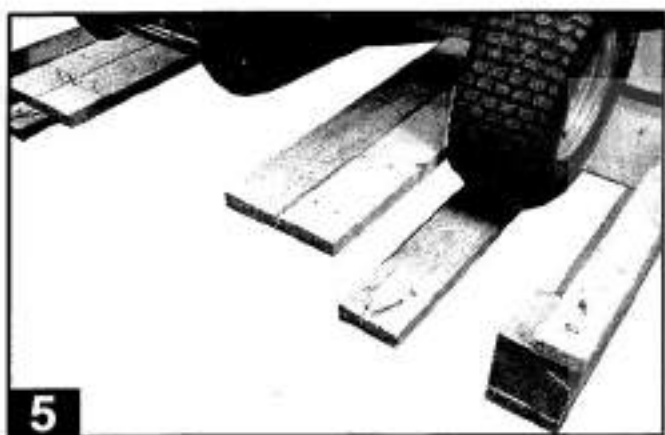
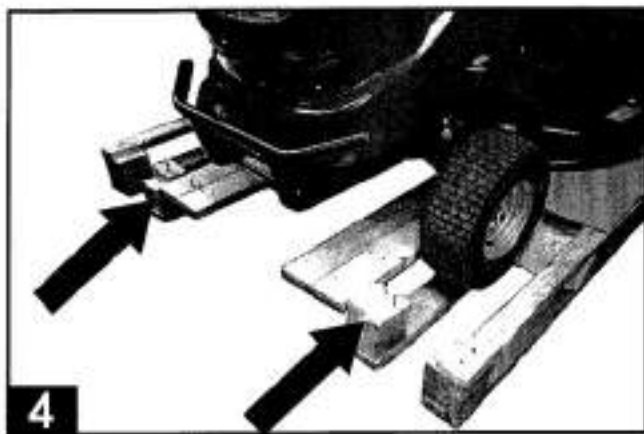
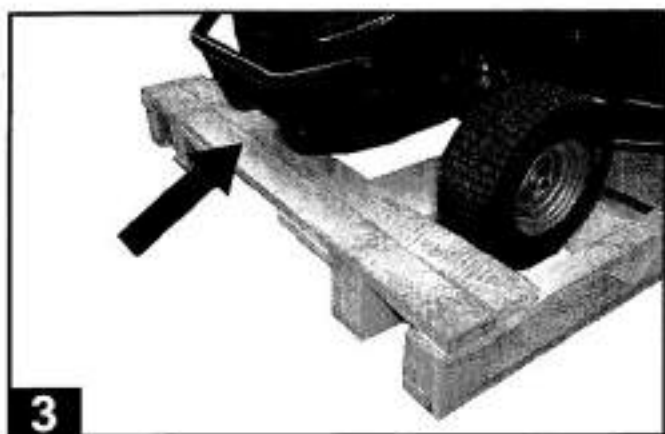
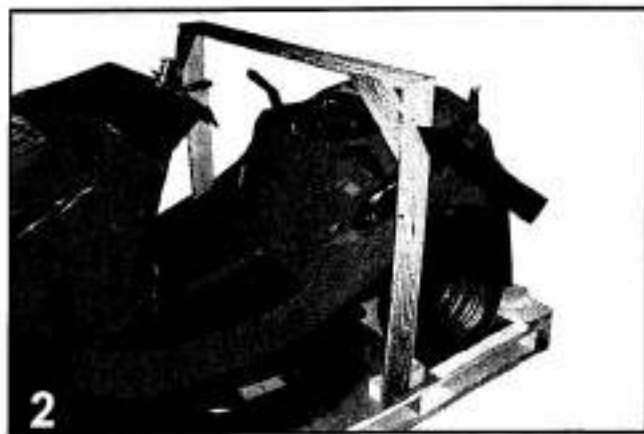
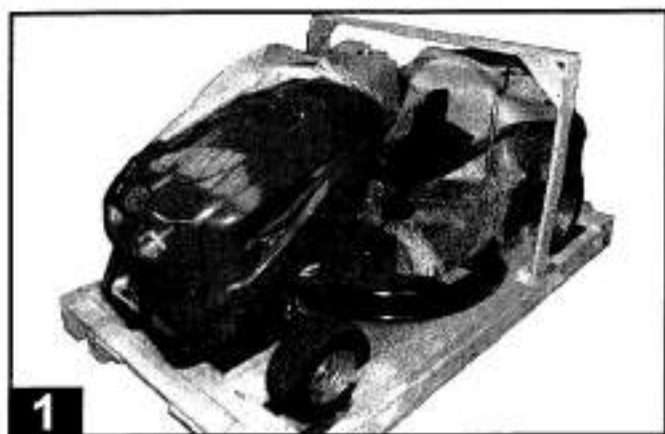

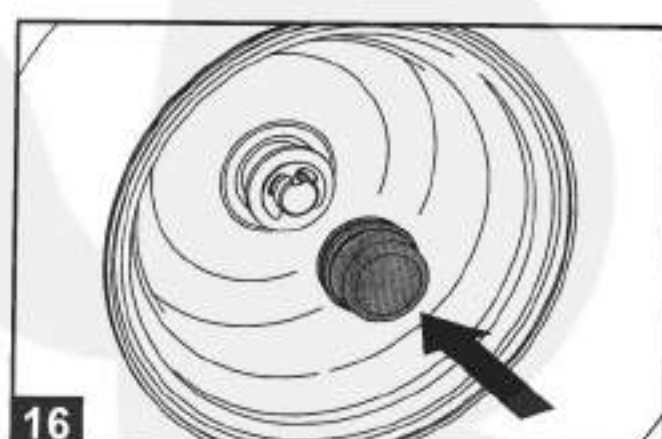
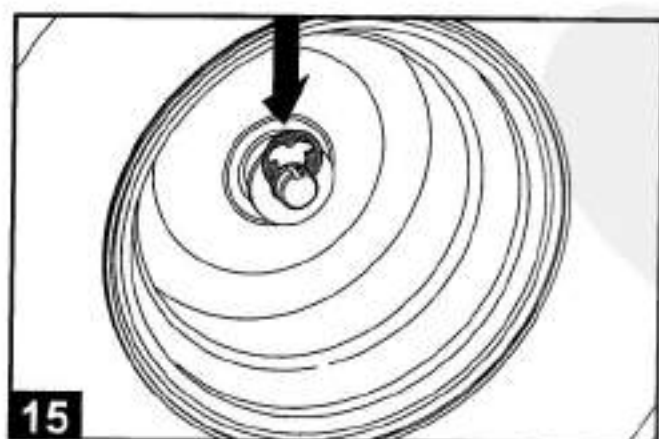
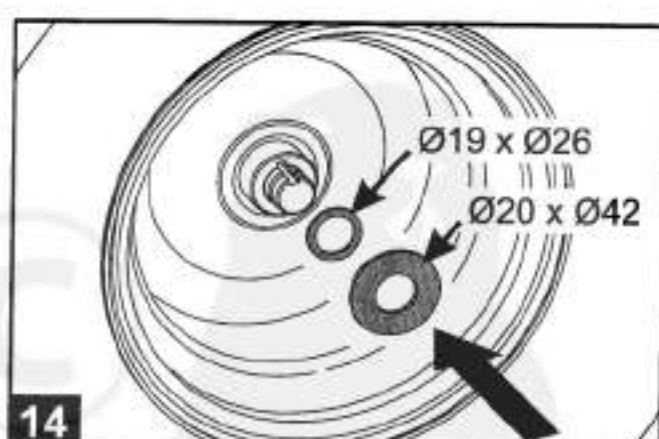
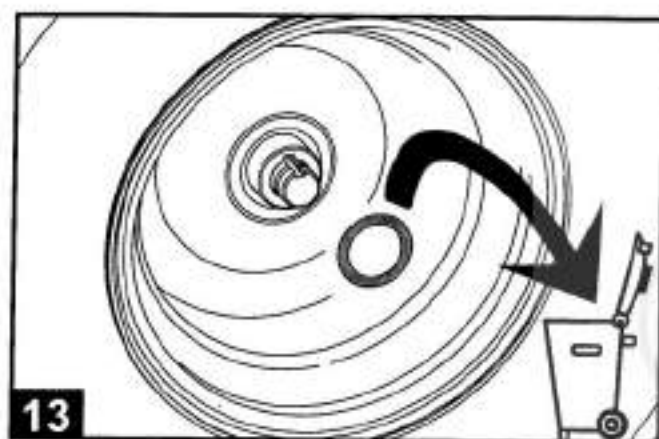
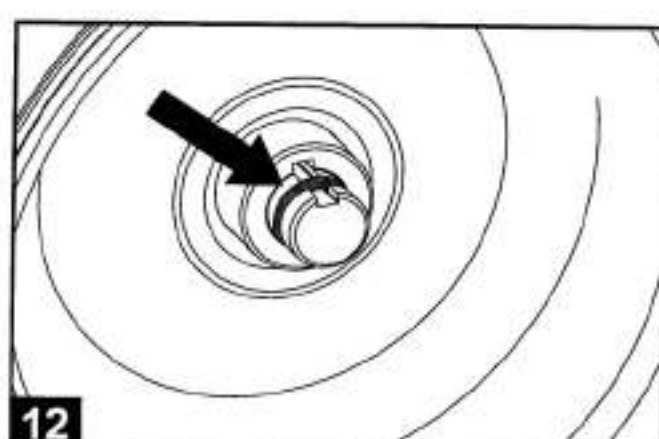
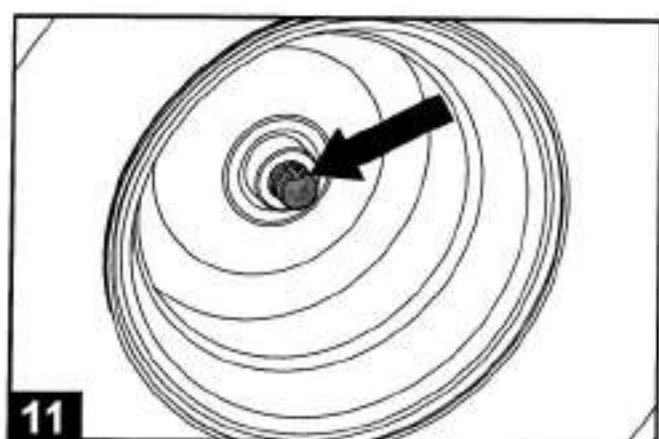
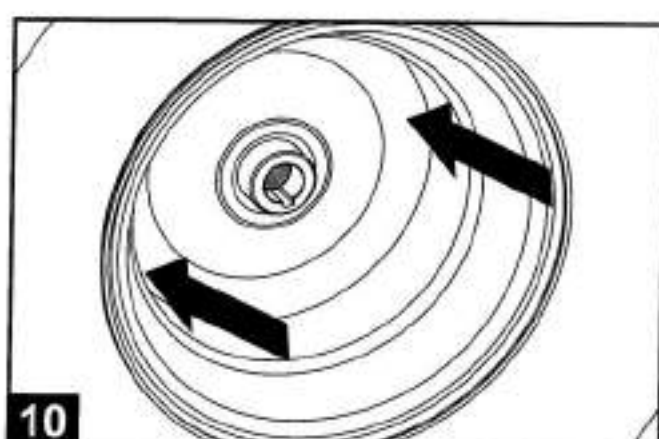
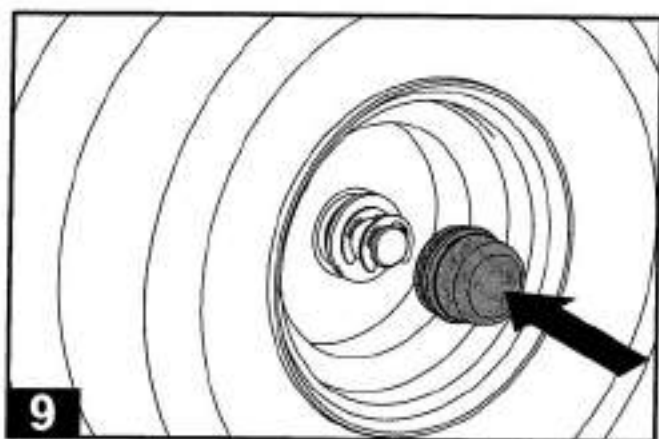

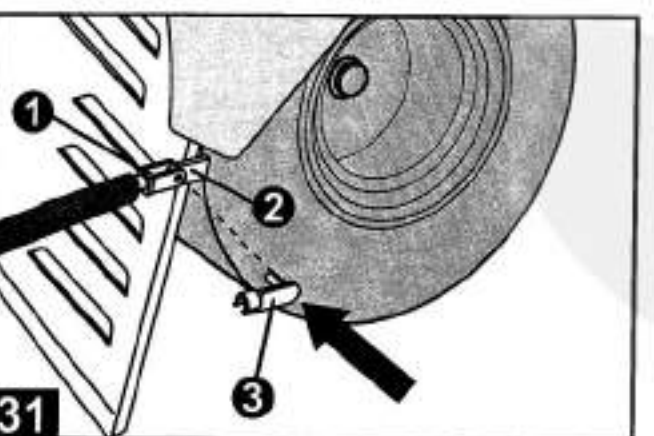
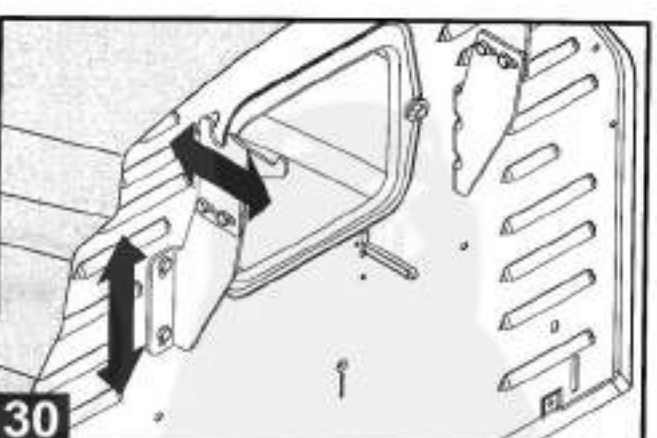
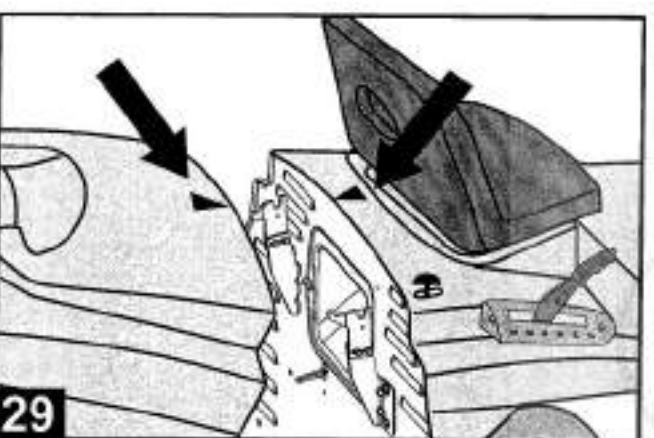
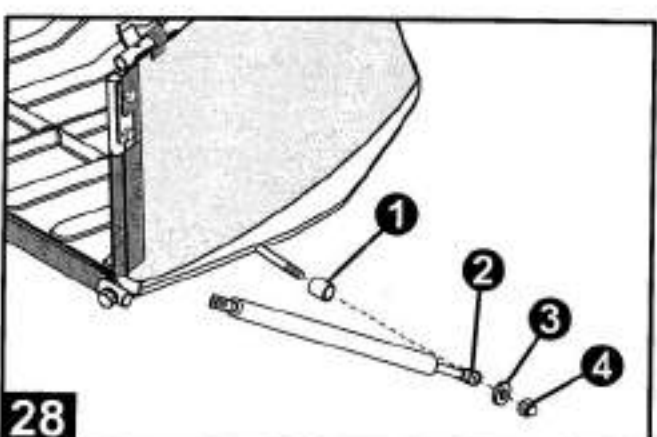
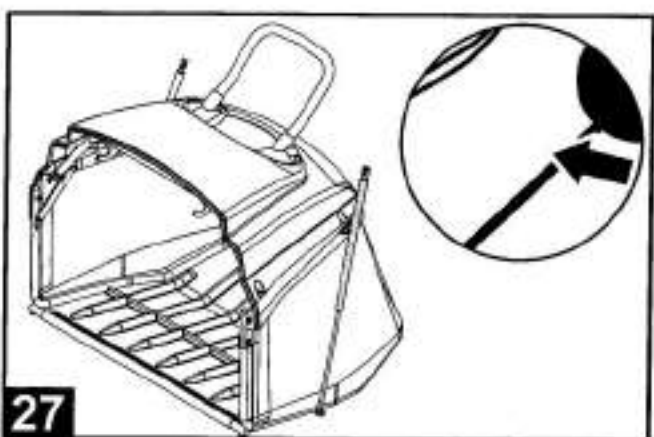
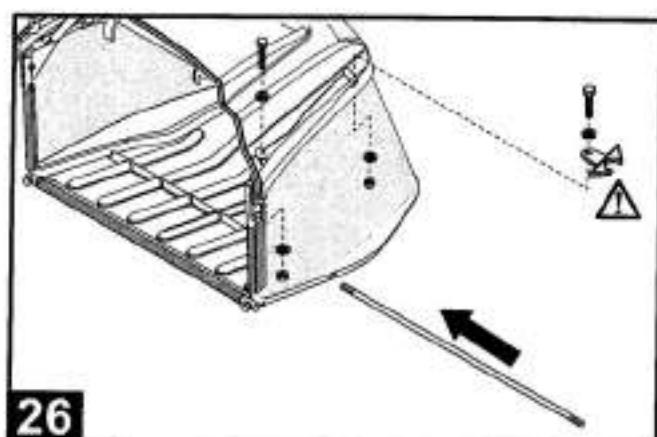
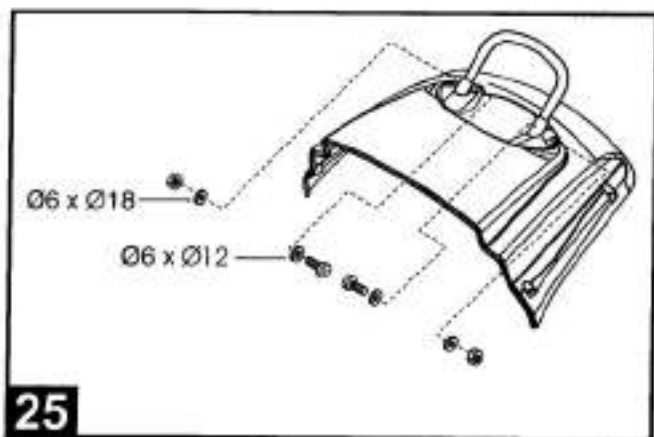

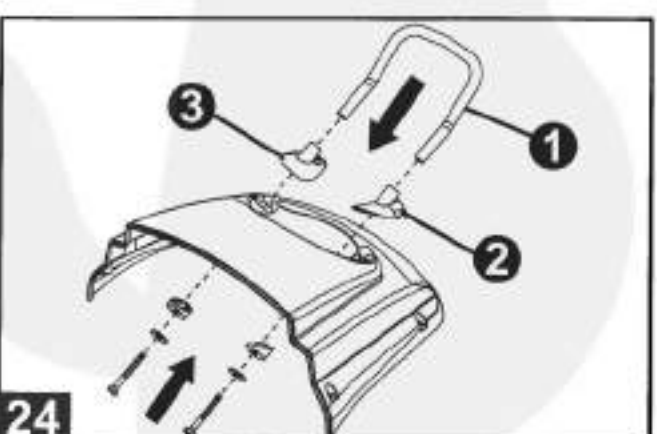
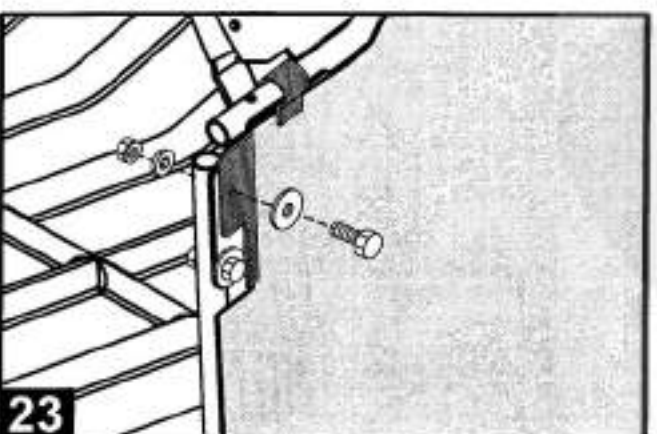
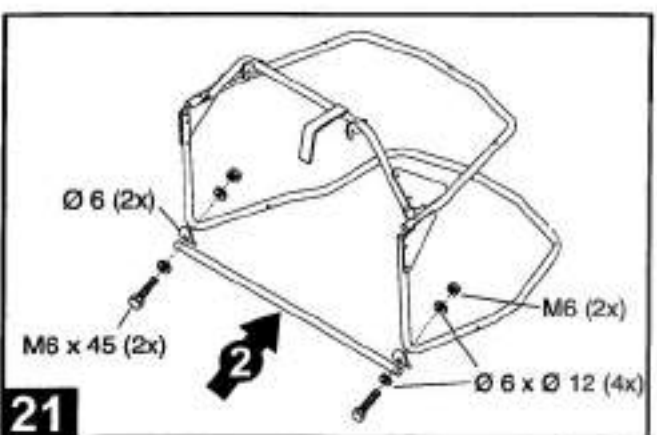
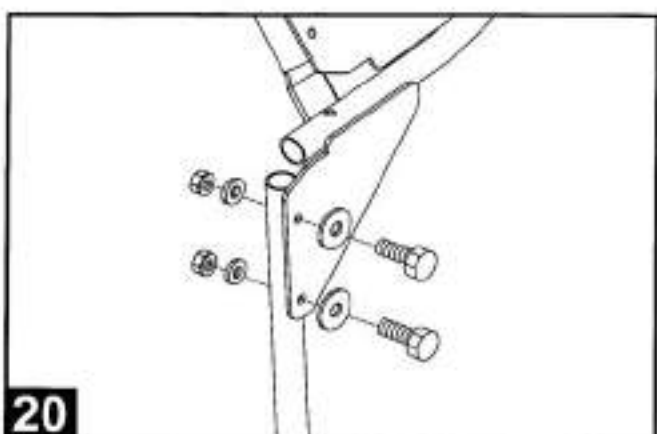
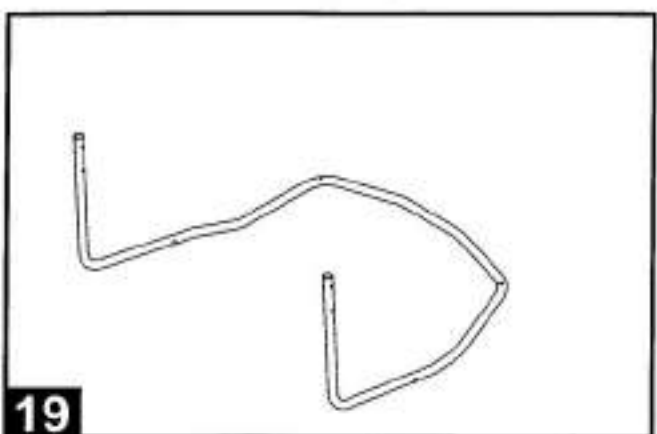
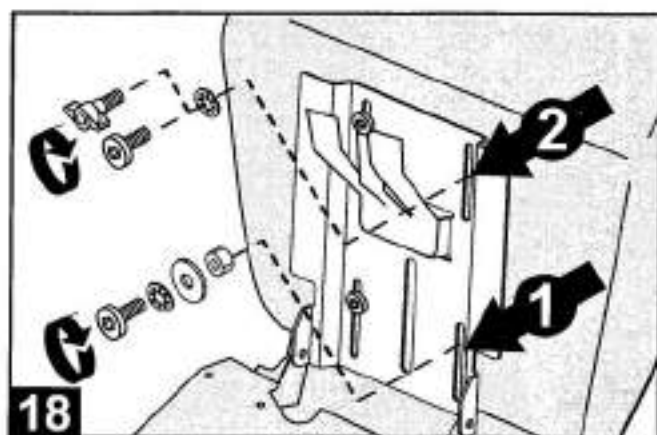
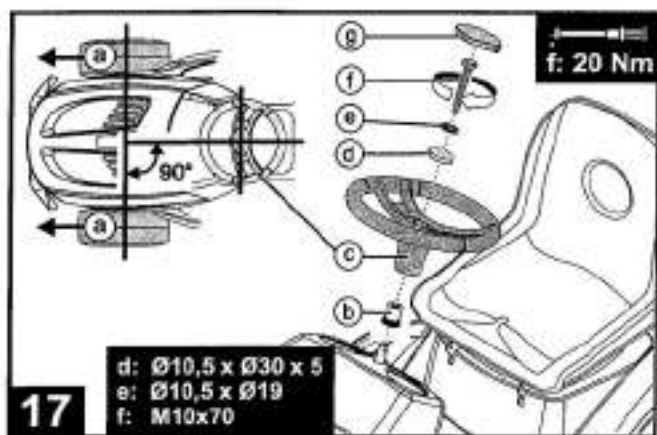

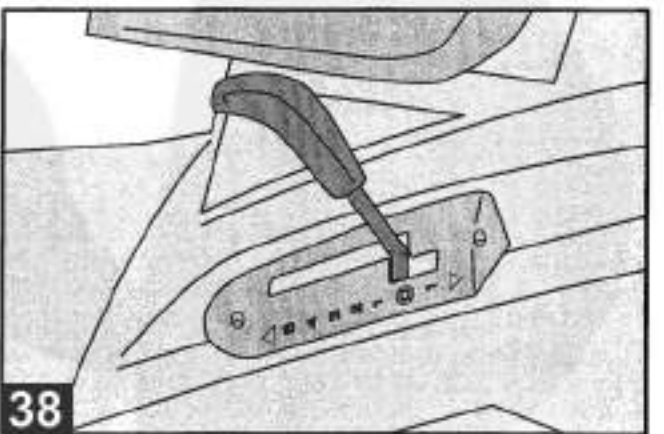
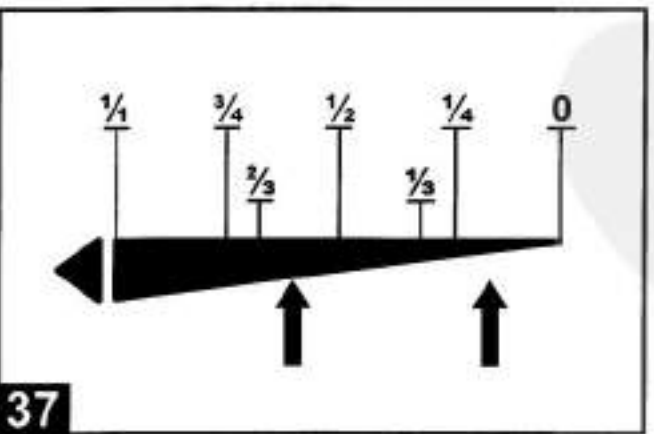
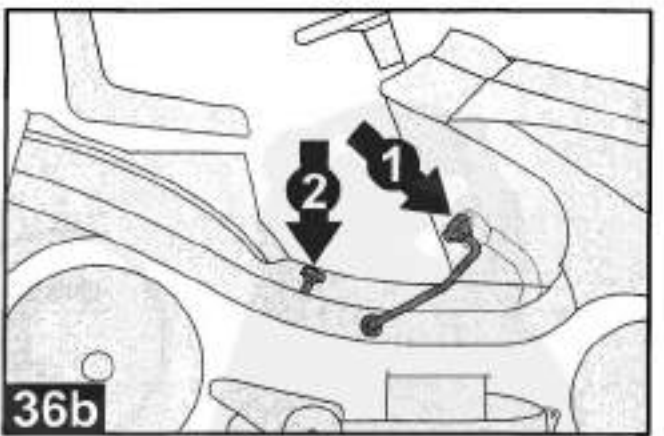
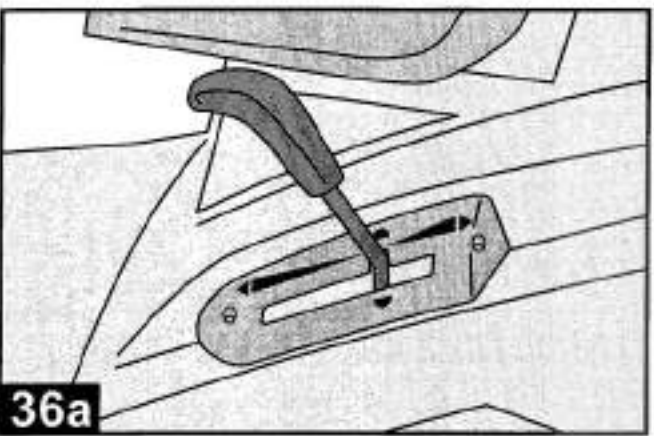
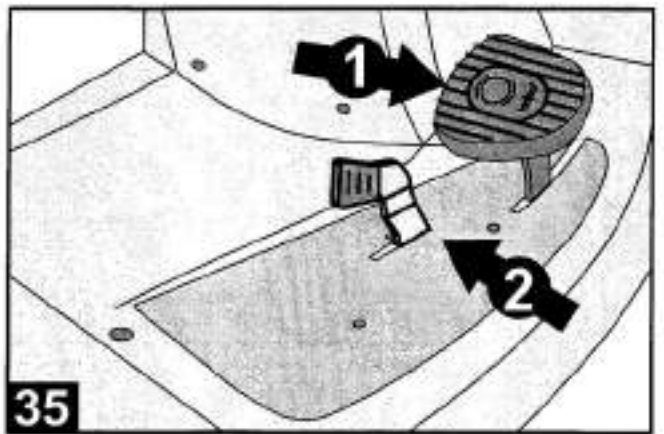
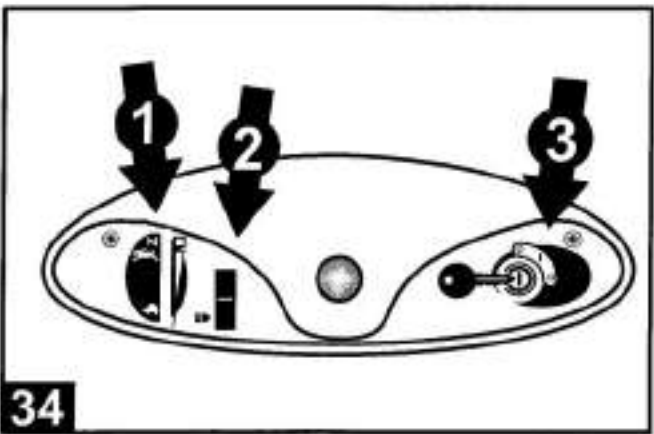
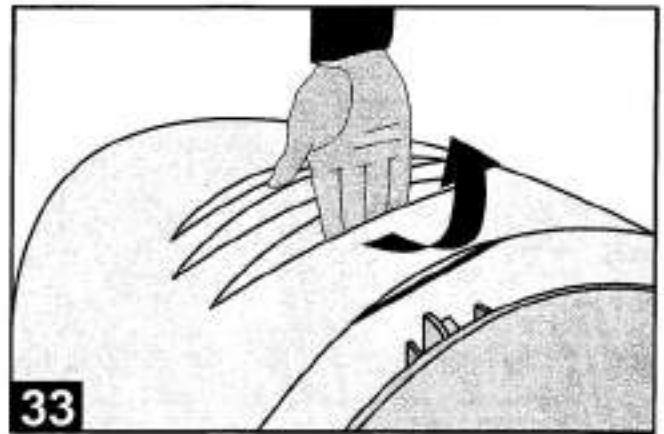
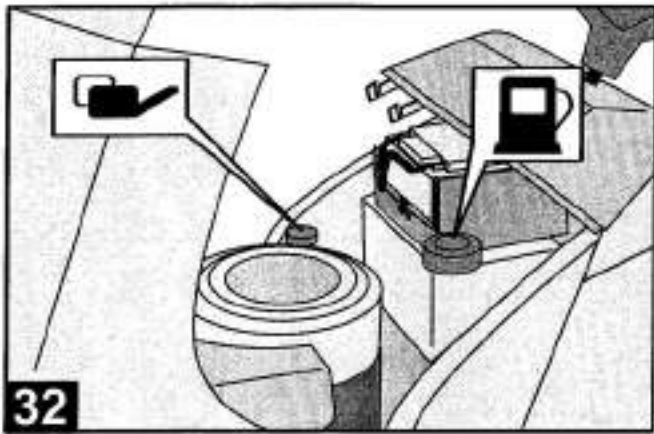

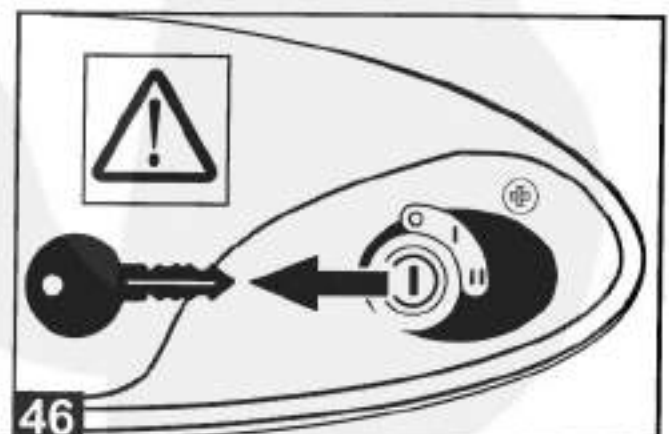
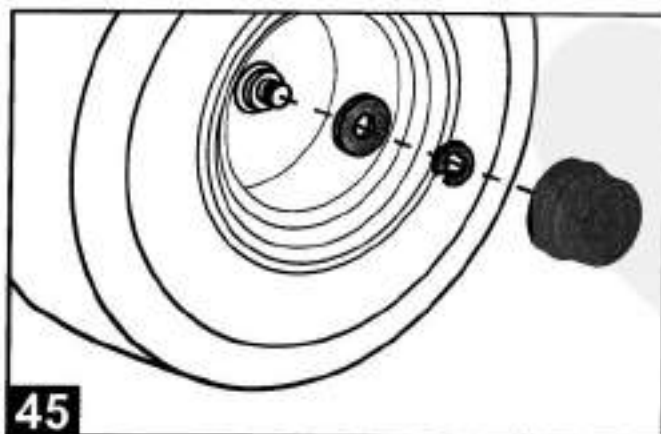
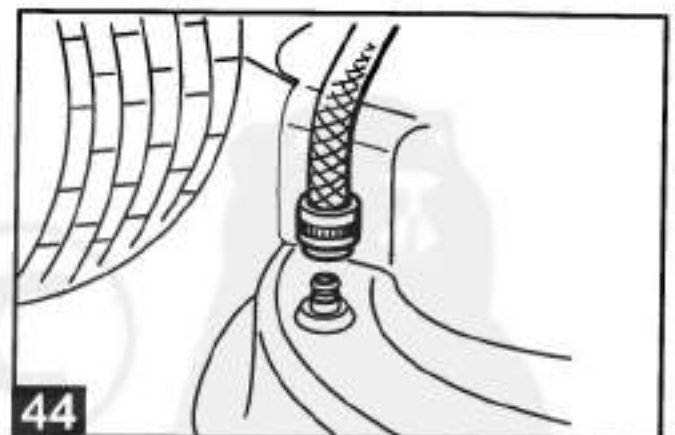
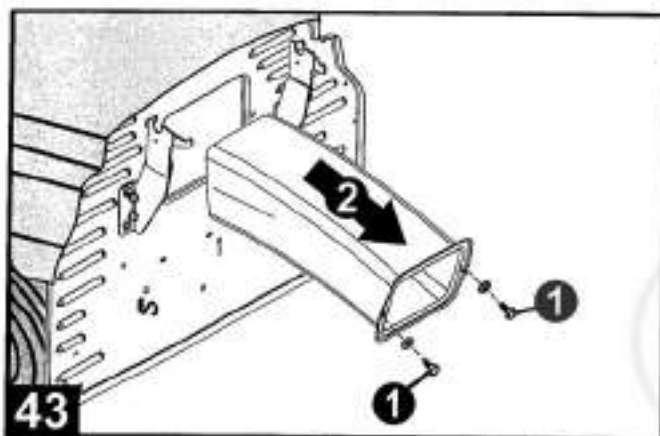
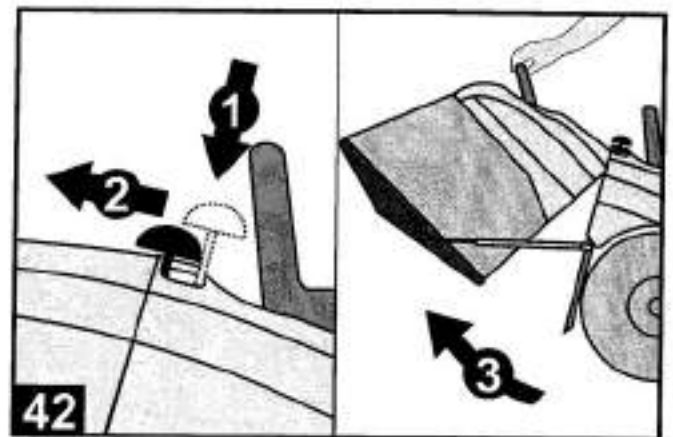
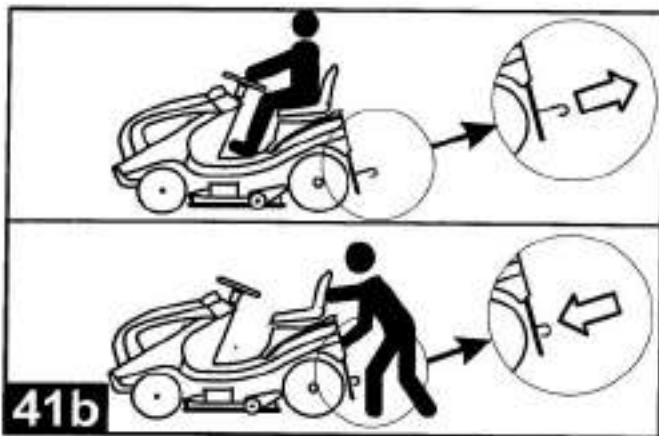
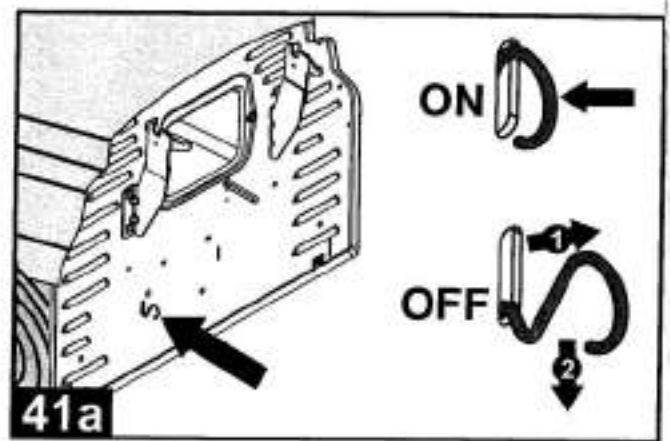
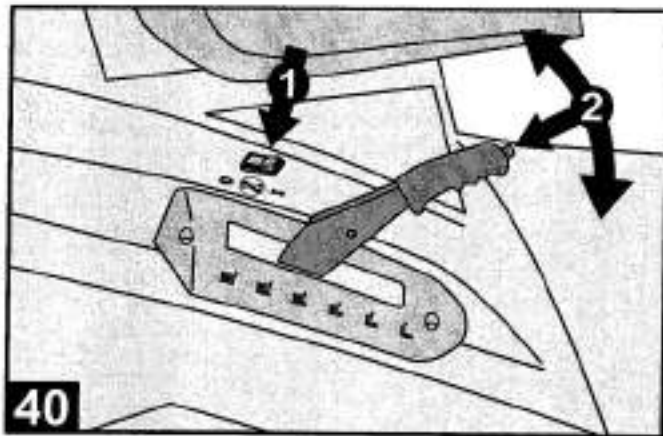



Before assembly and start of operation, please read the operating instructions at all costs and comply with them.

Dear Customer,
You have bought a totally tested quality product. However, should you have any reason for complaints, please get in touch with your dealer, stating the article and series number (see nameplate).

LIST OF CONTENTS

Manufacturer	
Introduction	.GB 9
Intended use	.GB 9
Meaning of symbols indicated on the mower	.GB 9
Safety precautions	.GB 10
Unpacking Lawntractor	.GB 11
Assembly	.GB 12
First operation	.GB 14
Operating elements	.GB 14
Start of operation	.GB 16
Care and maintenance	.GB 18
Starter battery	.GB 20
Storage in winter	.GB 21
Fault location plan	.GB 22
Guarantee card	.GB 23

INTRODUCTION

Dear customer,
You have purchased a new machine. We want to thank you for the trust that you put into our quality products and hope that you will have much pleasure from working with your new machine.

Before putting the machine into operation for the first time, please familiarise yourself with the contents of these operating instructions. If the machine is operated by people without sufficient qualifications or not according to the intended purpose, use of the machine may be dangerous. Please pay attention to the accident prevention directives.

Please pay attention to the safety instructions contained in these operating instructions and to the safety instructions on the machine.

Due to ongoing improvements of the product, the information contained in this manual is subject to alterations without the manufacturer being obliged to notify or to update, under the proviso that the essential properties for safety and operation do not change. In cases of doubt, please do not hesitate to contact your dealer.

INTENDED USE

This lawnmower is only intended for mowing in private gardens with a maximum inclination of 10° (18%) - not for public parks, sports grounds or in farming or forestry. Other kinds of use are only permitted with original spare parts.

Any other use is regarded as being misuse and results in forfeiture of the guarantee and rejection of any responsibility for damage to the user or third parties on the part of the manufacturer.

Working hours for lawn tractors:

Please observe the local directives for the operation of lawnmowers.

MEANING OF SYMBOLS INDICATED ON THE MOWER



Read operating instructions before start of operation.



Keep other people out of the danger zone.



Pull the ignition plug out before maintenance and repair work.



Do not use on slopes above 10° (18%).



Attention, danger!
Keep hands and feet away from the cutting gear.



While mowing, keep other people, in particular children and animals, away from the working area.



Danger: do not go here.

SAFETY PRECAUTIONS

1. General remarks

- 1.1 Read the operating instructions carefully. Familiarise yourself with the proper use of the machine.
- 1.2 People under 16 or people who have not read the operating instructions are not allowed to use the machine.
- 1.3 Do not operate the machine when there are others, in particular children or animals, in the area. The person using the machine is responsible for third parties in the working area of the machine.
- 1.4 The person using the machine is responsible for accidents involving other people or their property.
- 1.5 Please keep these operating instructions for later use.
- 1.6 The lawn tractor does not have approval according to the Highway Code. You are therefore not allowed to drive on public ways and roads with it.
- 1.7 Never mow on slopes with an inclination of more than 10° (18%).
- 1.8 No passengers may be transported on the machine.

2. Preparations

- 2.1 Always wear sturdy shoes and long trousers while mowing. Never go barefoot or wear open sandals.
- 2.2 Completely check the area on which the machine is to be used and remove any stones, sticks, wires, bones and other foreign objects. Always watch out for foreign objects when mowing.
- 2.3 - Petrol is to be poured in before starting the engine.
WARNING! Petrol is highly flammable!
 - Only keep petrol in the containers designed for this purpose.
 - Only fill the machine in the open and do not smoke when filling the machine.
 - The tank may not be opened or petrol topped up while the engine is running or when the machine is hot.
 - If petrol has been spilt, do not start the engine. Instead, remove the mower from the area contaminated with petrol. The spilt petrol must be sucked or wiped off the engine and the housing with a cloth. No attempts at ignition may be made until the vapours have disappeared.
 - Use a funnel or a filling tube when pouring in petrol so that no fuel can leak onto the engine or onto the lawn.
 - For safety reasons, replace the tank lid and the petrol tank if they are damaged.
- 2.4 The exhaust and the area around the exhaust can reach temperatures of up to 80°.
ATTENTION: danger of burning!
Replace damaged silencers.
- 2.5 Before use, always make a visual check to see if the blade, the fastening bolts or the entire cutting unit are worn or damaged. In order to avoid an imbalance, worn or damaged blades must be replaced with new ones.
- 2.6 Ensure that the movement of one blade can lead to rotations of the other blades when mowing with more than one blade.
- 2.7 An examination by an expert is necessary if the machine stops immediately, e.g. after impact with an obstacle (damage to the drive shaft, bent blades etc.).

3. Instructions for use

- 3.1 The combustion engine may not be operated in enclosed rooms in which dangerous fumes can collect - danger of poisoning!
- 3.2 Only mow your lawn in daylight or in good illumination. Please observe any local directives about when you are allowed to use the machine (see operating times for lawn tractors).
- 3.3 Before starting the machine, switch off the mowing appliance, put the drive into neutral and operate the parking brake.
- 3.4 Please remember that there are no "safe slopes". Mowing slopes with a lawn requires special attention. In order to protect yourself against tipping over, you should:
 - not stop or start suddenly if you are moving up or down the slope,
 - suppress the clutch slowly, leave the clutch depressed, in particular when driving down the slope,
 - keep the speed low on slopes and in tight bends,
 - pay special attention to hills, recesses and other invisible dangers,
 - never mow transverse to the slope if it has an inclination of more than 10°.
- 3.5 Always pay attention to road traffic when you are crossing roads or working in the vicinity of roads.
- 3.6 When driving the tractor, pay attention to low-hanging obstacles (branches, washing lines etc.) which can injure the driver.
- 3.7 Switch the mowing appliance off when driving off the lawn, lift it to the highest cutting position.
- 3.8 Never operate lawn tractors with a damaged housing or defective protective devices (e.g. grass box etc.).
- 3.9 Before leaving the driver's seat:
 - switch the mowing appliance off and wait until the blades come to a standstill,
 - switch the engine off and remove the ignition key.
- 3.10 Disengage the drive, turn the engine off and pull out the spark plug connector or the ignition key
 - before eliminating blockages or obstructions in the discharge channel
 - before checking or cleaning the mower or doing any other work on it
 - if a foreign body is hit. Look for damage to the machine and have the necessary repairs done before you start it again;
 - if the mower starts to vibrate unusually severely, an immediate check is necessary.
 - whenever you leave the mower unattended or transport it
 - before filling up with petrol
 - before removing the grass box.
- 3.11 The basic setting of the engine in the factory is correct and must not be altered.
- 3.12 Start and operate the starting switch carefully (see Chapter "Starting the engine"). Make sure that your feet are at a safe distance from the blade.
- 3.13 Do not tip the mower when starting or turning the engine on.
- 3.14 Do not start the engine if anyone is standing in front of the discharge channel.
- 3.15 Keep your hands and feet out of the area of the rotating blade. Keep other people away from the discharge channel when the blade is rotating.
- 3.16 Never use a lawn tractor with a rear discharge without a grass box or a vapour discharge.

4. Instructions for maintenance and storage

- 4.1 Make sure that the nuts, bolts and screws are tight.
- 4.2 Be careful when adjusting - danger of injuries. Do not trap your fingers between the housing and the blade. Wear protective gloves.
- 4.3 Never store the lawn tractor with fuel in the tank inside a building in which petrol fumes can possibly come into contact with naked flames or with sparks
- **danger of explosion!**
- 4.4 Only empty the petrol tank in the open.
- 4.5 Allow the engine to cool down before you put the machine into an enclosed area.
- 4.6 Avoid the risk of a fire by keeping the engine and the exhaust free of grass, leaves and grease (oil).
- 4.7 Check regularly to make sure that the grass box is in a satisfactory condition.
- 4.8 For safety's sake, worn or damaged parts must be replaced immediately.
- 4.9 Replacement blades and additional appliances may only be mounted on the lawn tractors intended for this purpose according to the manufacturer's instructions. This is the only way to maintain the safety and the performance of your lawn tractor.
- 4.10 Please ensure that the maintenance, checking and sharpening of the blade is only done by an authorised dealer.
- 4.11 Use original spare parts and accessories only.

We would point out that we are not liable according to the Product Liability Act for damage caused by our machine as a result of

- a) improper repairs not carried out by our authorised service agents,
- b) or if ORIGINAL SPARE PARTS are not used as replacement parts.

The same applies to accessories. A service booklet with the addresses of our authorised service agents is enclosed with the appliance.

Unpacking Lawntractor

The lawntractor will be delivered on a solid wood pallet.

To remove the packing, place the pallet on a level surface.

Please follow the sequence for unpacking and for the respective wheel locks.

The numbers to the left of the text, e.g. **5**, refer to the illustrations in the picture section of these operating instructions.

Open cardboard packing at top.

Remove staples and take off cardboard packing upward.

1 Remove enclosed parts and packing materials.

2 Remove wooden hoop.

3 Remove front laths.

4 Remove wooden blocks.

5  Remove all nails on the pallet.

Move mowing unit into highest position.
See operating instructions under:
>> Start-up - Adjusting cutting height <<

Lift tractor at rear and push off pallet.

Dispose of pallet and packing materials properly.

 Secure the tractor from rolling away with the wheel locks!

Now you can begin mounting equipment.

ASSEMBLY

The following assembly work must be carried out before the first operation:

1. Installation of the wheels.
2. Installation of the steering wheel.
3. Installation of the driver's seat.
4. Assembly of the grass box
5. Fitting the grass box to the lawn tractor.

Attention!

Putting into operation (even test operation) before complete assembly is strictly forbidden - dangers of accidents!

The information on directions (right, left, top etc.) for this appliance are to be understood in the direction of travel looking from the driver's seat.

The order of assembly steps is to be complied with, as otherwise flawless function cannot be guaranteed.

v

Please note:

The figures stated to the left of the text, such as the **5** here, refer to the illustrations in the illustrated part at the front.

Front wheels:

i Assembly front wheels
Only with 13"- wheels necessarily!



Lock both front wheels.

6

Lift tractor slightly by bumper and pull to front wheel.

7

Push washer toward wheel rim.

8

Insert lock washer into shaft groove before washer and press down.
2x lock washer dia. 15x29x1.5 - contained in screw/bolt bag.

9

Fit cover cap.

Rear wheels:



Lock both rear wheels.

10

Move tractor to rear wheel until rear wheel is heard to strike steering knuckle.

11

Wheel axle protrudes from rim.

12

O-ring $\varnothing 11 \times 2.6$ is fitted in the works - (secures the parallel key).

13

Remove O-ring - do not re-use

14

Fit one washer
1x 19 mm dia. x 26 mm dia. and
1x 20 mm dia. x 42 mm dia.
each on axle - first 19 mm dia. x 26 mm dia.!

15

Insert lock washer in shaft groove and press down.

16

Fit cover cap.

Assembly of the steering wheel

17

Align front wheels (a) straight ahead in the direction of travel.

Fit clamping sleeve (b) on steering column.

Place steering wheel (c) on clamping sleeve.
Observe position: Spoke must point towards driver.

Insert washer (d).

Push toothed lock washer (e) onto hexagon bolt (f).

Secure steering wheel with hexagon bolt.
Observe correct tightening torque: 20 Nm

Push on cover (g).

Installing the driver's seat

18

Unscrew the driver's seat according to the diagram on the hinged console.

Hexagonal recess hole screw M6 x 20	(2 x)
Fan-disk $\varnothing 8.4 \times \varnothing 15$	(2 x)
Disk $\varnothing 8.4 \times \varnothing 24$	(2 x)
Spacer bushing $\varnothing 8.2 \times \varnothing 14$	(2 x)
Hexagonal recess hole screw /	
Wing screw M6 x 20	(2 x)
Fan-disk $\varnothing 8.4 \times \varnothing 15$	(2 x)

Push the seat into the required position and tighten the screws by means of the enclosed socket wrench - 6 mm (Allen key)!

The seat can be moved in a longitudinal direction by loosening the screw .

Assembling the grass box

- 19** Place the lower part of the frame on a suitable base (e.g. a table).

- 20** Screw the upper part of the frame onto the lower part of the frame on both sides.

M 6 x 35 hexagonal head screw	(4 x)
Ø 6 x Ø 18 shim	(4 x)
Ø 6 x Ø 12 shim	(4 x)
selbstsichernde Mutter M 6	(4 x)

Attention!

Only tighten the nuts by hand to start with due to the subsequent fixing of the box fabric.
Fit disk Ø 6 x Ø 18 under the screw head!

- 21** Screw the transverse tube onto the box frame.

M 6 x 45 hexagonal head screw	(2 x)
Ø 6 x Ø 12 shim	(4 x)
Ø 6 curved shim	(2 x)
M 6 self-locking nut	(2 x)

- 22** Place the frame onto the box base of the fabric sack.

Attention!

The ribs of the box base pointing upwards.
Clip the fabric sack onto the box frame.

- 23** Remove the upper frame screw connection and screw the fitting flap of the fabric sack together with the upper and lower part of the box frame.

Fit the Ø 6 x Ø 18 shim under the screw head.
Carry out this procedure on both sides.

- 24** Clip the stopper into the opening on the right-hand side of the box lid.

Screw the contact elbow for the box switch onto the box lid.

Ø 6 x 25 counter-sunk screw	(2 x)
-----------------------------	-------

Attention!

Make sure that the position of the contact elbow is as shown.

- 25** Screw the box handle onto "superstructure left" and "superstructure right".

M 8 x 60 screw	(2 x)
Ø 6 x Ø 15 shim	(2 x)
shim	(2 x)

Attention!

The connection contours of the two superstructures must correspond with the outer contour of the box lid.

26

- Screw the box handle onto the box lid

M 6 x 20 screw	(2 x)
Ø 6 x Ø 12 shim	(2 x)
Ø 6 x Ø 18 shim	(2 x)
M 6 self-locking nut	(2 x)

27

- Position the box lid and screw onto the box frame

M 6 x 40 hexagonal head screw	(5 x)
Ø 6 x Ø 18 shim	(5 x)
Ø 6 x Ø 12 shim	(5 x)
M 6 self-locking nut	(5 x)
Holder	(2 x)

28

Attention!

Fit the Ø 6 x 18 shim under the screw head.

Push the box strut (Ø 8 mm) through the base of the box and the lower part of the frame.

Attention!

The box strut must protrude by the same distance on both sides of the box.

29

- Thread the gas spring onto the box strut in the order shown and screw tight. Carry out this procedure on both sides.

Ø 12 x 13 spacer bushing	(2 x)
Gas-pressure spring	(2 x)
Ø 6 x Ø 15 shim	(2 x)
M 8 self-locking cap nut	(2 x)

Attention!

Only tighten the cap nuts to such an extent that the gas-pressure springs can still be pivoted.

Assembling the grass box on the tractor

30

- Hold the grass box by the box handle in one hand. With the other hand - gently pressing onto the box lid - position the upper part of the frame onto the box holding arms and push forwards until the grass box engages in the bearings.

Attention!

The arrows on the box lid and the seat console must match.

31

- If the gap between the box lid and the seat console is too large, the box holding arms can be adjusted by loosening the screws in the directions shown.

32

- Push the forkhead of the gas-pressure spring across the fitting lug of the back wall until the bores are flush.

Push the securing bolts through the forkhead and the lug and lock them.

Carry out this procedure on both sides.

FIRST OPERATION



The lawn tractor may only be put into operation when the assembly has been completed.

Safety systems

The lawn tractor is fitted with 3 safety contacts which are operated by

- the driver's seat
- the grass box and
- the foot pedal.

The engine can only be started if

the driver is sitting on the driver's seat, the brake has been operated and the mowing appliance has been switched off.

The engine is automatically switched off if

- the driver gets off without operating the brake
- the driver gets off with the mowing appliance still running
- the grass box is opened or removed with the mowing appliance still running.

33

Filling with engine oil and fuel.

34

Opening the bonnet:

- Put your hands into the ventilation slots of the bonnet.
- Gently pull the bonnet in the direction of the steering wheel and lift it up until it makes contact with the bumper.

Pour engine oil in before the first operation

- see operating instructions of the engine manufacturer.

Regularly check the oil level.

Fuel: standard petrol - lead-free.

TAKE CARE WHEN POURING FUEL IN

Only fill the petrol tank in the open. Do not smoke. Do not pour in petrol when the engine is running or hot.

Use a suitable funnel attachment or feeder funnel to pour in petrol so that no fuel can be spilled on to engine, the housing or on the lawn. If petrol is spilled, do not start the engine. Remove the mower from the area contaminated with petrol. The spilled petrol must be sucked or wiped off the engine and the housing with a cloth. No attempts at ignition may be made until the vapours have disappeared.

Tyre pressure

Check the tyre pressure at regular intervals.

Examine the precise air pressure on the tyre.
1 PSI = 0.07 bar

The tyre pressure can be checked without any difficulties by using a standard foot-pump.

Starter battery

As a matter of principle, the starter battery is charged ex works. Should starting problems nevertheless occur, the battery must be charged before the first operation of the lawn tractor.

During the operation, the starter battery is charged by the engine. Under normal conditions, re-charging will only be necessary after longer periods without use (longer than 3 months).

Charging the starter battery: see "Maintenance and Service".

We recommend charging this maintenance-free and gas-tight battery with a charging device specifically suited for this (can be purchased from specialist dealers).

If a different charging device is used, the charging current may not exceed 5 A and the charging voltage 14.4 V. If there is a higher charging voltage, there is a danger of the starter battery exploding.



The starter battery is recyclable.



Used and defective starter batteries must not be disposed of via domestic refuse. Your dealer, the manufacturer of the device or the local battery collection points (pay attention to the local directives) will assure proper disposal of these batteries.

OPERATING ELEMENTS

35

Gas lever

The engine speed is regulated with the gas lever. In order to mow as effectively as possible, the gas lever should be switched to



Light switch

Use the light switch to switch the headlights on.

Ignition lock

To start the engine, put the ignition key into the ignition lock and turn to the right to position "II".

As soon as the engine is running, let go of the ignition key (ignition key returns to position "I").

To switch the engine off, put the gas lever onto



then turn the ignition key onto position "0".

40

Mowing appliance switch

The mowing appliance is operated with this toggle switch.

Switch position I - mowing appliance switched on
Switch position 0 - mowing appliance switched off

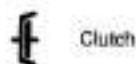
36 Meaning of the symbols on the foot pedal

Clutch



Brake

36 Foot pedal - right "clutch / brake"

If the pedal is half pushed down, the clutch is disengaged. If the pedal is completely pushed down, the clutch is disengaged and the disk brake of the transmission operated.

With the pedal completely pressed down, the pedal can be locked in the "Brake" function by pushing the stop lever to the left (with the heel of the shoe).

Pushing the pedal down again cancels the locking - the stop lever returns to the original position.

Operating elements for driving according to lawn tractor type:

1. with hand switching lever (for hydrostat drive)
2. with foot pedal (for hydrostat drive)
3. with 5-gear transmission

37a Hand switching lever (for hydrostat drive)

Possible transmission positions:

Forward gear - infinitely adjustable
Reverse gear - infinitely adjustable
and a neutral position.



For safety reasons, the switching lever must always be in the neutral position when engaging traction. 

37b Foot pedals (for hydrostat drive)

Possible transmission positions:

Forward gear: - infinitely adjustable,
Reverse gear: - infinitely adjustable
and an automatic position.

39 Switching lever (for 5-gear transmission)

With the switching lever,

5 forward gears
1 reverse gear
and 1 neutral position can be switched.

40 Position lever for adjustment of cutting height

The mowing appliance is lifted or lowered with the position lever.

Six positions are available. In order to get from a higher to a lower position, the push button on the end of the lever must be pushed to unlock it.

In order to reach a higher position, simply push the lever upwards into the required position.

START OF OPERATION

Starting the engine

Attention!

Check the oil level before each start of operation.

Engine exhaust fumes contain carbon monoxide, a non-odorous and lethal gas!

For this reason, never start the engine in enclosed or badly ventilated rooms.



- Sit down on the driver's seat.
- Push the right-hand pedal (clutch/brake) right down - possibly engage with the stop lever.
The mowing appliance must not be switched on.

- For a cold start, put the gas lever onto CHOKE 

Type: 18 PS and 20 PS

Pull the CHOKE button out

- If the engine is warm, put the gas lever onto FAST 
- Put the ignition key into the ignition lock.
- Turn the ignition key to the right to position "I" (Start).
- When the engine is running, let go of the ignition key. (The ignition key automatically returns to position "I").
- An attempt at starting should only last for about 5 seconds so that the starter battery is not strained unnecessarily.

- As soon as the engine is running, put the gas lever into a position between  and 

Type: 18 PS and 20 PS

Push the CHOKE button back until it engages audibly. If the choke button remains in the pulled position with the engine running, the engine does not perform as well as it can (engine smokes, spark plugs soot up, increased fuel consumption).

Hydrostatic drive

Winter operation – in temperatures below 0°C

- Release transmission / brake pedal.
- Start motor and set the switch lever for the hydrostatic drive into the neutral position for approx. 30 seconds – optimisation of transmission oil viscosity.
- Only then begin driving operations.
- The engine should warm up for a few minutes before the mowing appliance is switched on.

Stopping the engine

- Switch off the mowing appliance.
- Put the gas lever onto 
- Briefly press the brake pedal down - if necessary, engage the brake pedal.
- Turn the ignition key to the left to position "0".
- If the lawn tractor is left unused or unattended, remove the ignition key and engage the brake pedal.

Driving with the lawn tractor

- Push the right-hand pedal (clutch/brake) right down - possibly engage with the stop lever.
The mowing appliance must not be switched on.
- Start the engine.

with 5-gear transmission:

- When the engine is running, select the required forward or reverse gear.

 For the first use of the lawn tractor, we would advise you to only select 1st gear.

- To start motion, slowly release the clutch/brake pedal.



Do not switch the 5-gear transmission while driving. The lawn tractor must be stationary in order to change gear.

with hydrostat-drive / with hand switching lever:

- When the engine is running release the brake - (remove your foot from clutch/brake pedal).
- Select forward or reverse drive with the hand switching lever.

 For the first use of the lawn tractor, we would advise you to only drive at minimum speed.

with hydrostat-drive / with foot pedal:

- When the engine is running release the brake - (remove your foot from clutch/brake pedal).
- Select forward or reverse drive with the appropriate foot pedal.

 For the first use of the lawn tractor, we would advise you to only drive at minimum speed.

Brakes

- Press the right-hand pedal down completely in order to brake. 

Switching the mowing appliance on

- Only switch the mowing appliance on with the engine running.
- Put the gas lever into the  position.
- Put the mowing appliance switch onto position "I".
- Set the required cutting height.

Attention!

Before switching the mowing blade on, allow the engine to warm up for about 1 minute!

When you switch the mowing appliance on, the mower should not be standing in long grass. Set to the highest cutting height.

Switching the mowing appliance off

- Put the mowing appliance switch onto position "0".
- The mowing appliance can be switched off both at a standstill and also during movement.

Attention!

A rotating / slowing blade can cut hands and feet. Therefore, keep your hands and feet away from the blades.

Setting the cutting height

- 40** The blades are raised and lowered with the position lever to the right of the driver's seat.

Six height settings with a cutting height between 30 and 90 mm are possible.

Allow the position lever to engage at the height adjustment position required.

Adjustment of the cutting height can be done both at a standstill and also during movement.

Attention:

Set the highest cutting height:

- before switching the cutting appliance on
- when driving without mowing

Driving without traction (pushing)

Attention!

Only with the engine switched off and the blades stationary!

- a) For a 5-gear transmission:
1. Put the switch lever into position 0.
 2. Release the brake.

- 41a** b) For a hydrostat drive with hand switching lever:
1. Remove or lift up the grass box.
 2. Pull out bypass lever and engage downwards
 3. Release the brake.
- The lawn tractor can now be pushed without any difficulty.

- 41b** c) For a hydrostat drive with foot pedal:
1. Remove or lift up the grass box.
 2. Push in the bypass lever and engage (downwards).
- The lawn tractor can now be pushed without any difficulty.

Driving and mowing

In order to achieve a tidy mowing result, the traction speed must be adapted to the state of the lawn.

- 38** a) Lever / pedal position for hydrostat drive:

- long / thick grass and wet grass: 0 - 1/4
- normal grass, weekly cutting: 1/2 - 2/3

The lever / pedal positions from 2/3 - 1/1 are reserved for driving without mowing.

- 39** b) Lever position for 5-gear transmission:

- long / thick grass and wet grass: 1st gear
- normal grass, weekly cutting: 2nd - 3rd gear

4th and 5th gear are reserved for driving without mowing.

In a normal case, the cutting height is about 4-5 cm. This corresponds to the 2nd/3rd position of the height adjustment. Cut moist or wet grass with a higher cutting height.

The best thing to do with very long grass is to cut it twice. For the first cut, set the machine to max. cutting height and set it to the required height for the second cut.

Driving on slopes

Special care is needed when driving on slopes. Please observe the following information:

- Do not drive on slopes with an inclination of more than 10° (18%).
- Do not jolt when starting.
- Keep the speed low.
- Do not stop or accelerate strongly.
- Do not declutch when going down the slope.

Emptying the grass box

The grass box can be emptied from the driver's seat.

Attention!

When the grass box is full, an acoustic signal can be heard. The box should be emptied now at the latest.

Switch the mowing appliance off - acoustic signal goes off.

42

Empty the grass box:

- Press the box locking button.
- Push the box locking button backwards until it engages.
- Pull the grass box upwards by hand.

Shake the grass box a number of times in order to empty it completely.

If the grass box is lifted or removed with the mowing appliance still switched on, the motor cuts out.

Closing the grass box:

1. Press the box locking button.
2. Push the box locking button forwards until it goes up again.
3. Push the grass box down by hand until it engages in the lowest locking position.

Attention!

If the grass box is not positioned properly, the mowing appliance cannot be switched on.

CARE AND MAINTENANCE

Cleaning the lawn tractor

In order to work properly, the lawn tractor must be cleaned regularly.

After each use, clean adhering residue from the lawn tractor and the grass box.

Grass box

Take the grass box off the lawn tractor.

28

The gas springs must be removed before you can take the grass box off the lawn tractor.

Clean the fabric sack from the outside with a jet of water.

If necessary, also clean the inside of the fabric sack with a brush.

Housing / engine / transmission

The engine and all the bearings (wheels, transmission, blade bearings etc.) must not be cleaned with water, in particular not with a high-pressure cleaner.

Any water penetrating into the ignition unit, into the carburettor and the air filter can cause damage. Water in the bearings can lead to a loss of lubrication and thus to the destruction of the bearings.

To remove dirt and residue of grass, use a cloth, a hand-held sweeper, a long-handled brush etc.

Electrical unit



Do not clean the electrical unit with water. Penetration of water into the electrical unit (switch, display, cable, operating elements etc.) can lead to damage.

Discharge channel

43

The ease of movement of the adjustment of the cutting height is guaranteed by regular cleaning.

The discharge channel comprises two parts pushed into one another.

The lower part is firmly attached to the mower housing. The upper part can be removed for cleaning.

The grass box must be taken off before you can remove the discharge channel.

Remove screw connection on the left and right of the discharge channel.

Attention!

There is a shim under each screw.

Pull discharge channel out backwards through the rear wall. Thoroughly clean the upper and the lower discharge channel.

The discharge channel is put back in reverse order.

Replacing and resharpening the mowing blade

At the end of the mowing season always sharpen the mowing blade or, if required, replace the mowing blade with a new one. Always have the mowing blade resharpened or replaced by a customer service centre (measurement of imbalance).

Unbalanced blades will cause the lawn mower to vibrate violently – risk of accident!

44

Mowing system

On the mowing deck, there is a connection for a 1/2" water hose coupling.
The mowing system can be cleaned by connecting a water hose.

During the cleaning process, the grass box or a suitable accessory must be fitted.

1. Lower the mowing deck to the lowest cutting height.
2. Start the engine - set a medium engine speed.
3. Switch the mowing appliance on.
4. Connect the hose to the connection and turn the water on.

After a few minutes, the mowing system has been cleaned.

5. Leave the mowing system to run for a few more minutes in order to spin the water out.
6. Clean the grass box and leave to dry.

Checking by a qualified service agent is necessary:

- after impact with an obstacle
- if the V-belt is defective
- if the engine comes to an immediate standstill
- if the brake performance drops
- if the blade is bent (do not straighten)
- if the drive belt slips
- if the blade shaft is bent (do not straighten)
- if there is a defect in the blade holder
- if there is damage to the transmission.

MAINTENANCE AND SERVICE

Maintenance, service and cleaning work may only be carried out when the machine has been turned off and has cooled down and the ignition key has been removed.

The following tasks may be carried out by the user himself. All the other maintenance, service and upkeep tasks must be carried out by a qualified service agent.

	Before each use	After each use	After the first 5 hours	After 25 hours of operation	After 50 hours of operation	Before each storage
Check level of engine oil	n					
Change engine oil			n			n
Clean the air filter				n		
Replace the air filter					n	
Check the spark plug					n	
Check the brake	n					
Check the tyre pressure	n					
Check mowing blade	n					
Check for loose parts	n					n
Check drive belt				n		
Clean the lawn tractor		n				
Clean air intake grille on engine	n					n
Clean grass and cuttings from transmission				n		
For hydrostat drive: Clean ventilator for transmission cooling		n				
Lubrication plan 1. page GB 20						

)* see operating instructions of the engine manufacturer

In cases of high load and high temperatures, shorter maintenance intervals than those stated in the table may be necessary.

Lubrication plan

In order to ensure the ease of movement of the moving parts, we recommend lubricating the following parts after 10 hours of operation.

Front axle:

Steering swivel right and left (lubrication nipple):
- with multi-purpose grease

Bearing of the front axle on the frame
- with spray oil

Steering:

Gear segment and steering pinion on steering gear
- with multi-purpose grease

Front / rear wheels:

roller bearings and hub
- with multi-purpose grease

For lubrication of the axles, the front and rear wheels must be dismantled (see Change of Wheels).

Pivots and bearings:

Lubrication of all moving pivot and bearing points, as well as the cable pulls:
- with spray oil.

Oil change

See operating instructions of the engine manufacturer.

The oil change can be done by sucking the oil out via the oil filling opening (a corresponding suction device can be purchased from your dealer).

Attention!

Dispose of used oil in accordance with statutory directives. Do not discharge used oil into the sewers or the ground. Contamination of groundwater is severely punished. All garages take back used oil, or your local authority can tell you where to dispose of it.

Air filter and spark plug

See the operating instructions of the engine manufacturer.

Transmission / hydro-transmission

The transmission needs no maintenance as it has been given a life-time filling of oil in the factory.

To remove dirt and grass residue, use a cloth, hand-brush, long-handled thin brush etc.

Check tyre pressure

Check the tyre pressure at regular intervals.

Examine the precise air pressure on the tyre,
1 PSI = 0.07 bar

The tyre pressure can be checked without any difficulties by using a standard foot-pump.

Wheel change

45

A wheel change may only be done on a level and firm base.

1. Park the lawn tractor with the parking brake and secure it against rolling away with wedges.
2. Lift the lawn tractor on the side of the wheel to be changed and place a suitable object (e.g. a block of wood) under a supporting element of the chassis.
3. Push the securing shim off with a screwdriver and remove the spacer shim.
4. Pull the wheel off the axle.

Attention!

Do not lose the adjusting spring when pulling the rear wheels off the axle.

When putting back together, grease the axles with customary multi-purpose grease.

STARTER BATTERY

There is no charging device for the starter battery included in the scope of delivery of the lawn tractor.

Precise designation of the battery: see battery box.

The starter battery can be found underneath the bonnet.

As a matter of principle, the battery has been charged in the factory.

Further charging is necessary:

- a) before storage for the winter break
- b) if the machine is not used for a long time (longer than 3 months).

Attention!

We recommend charging this maintenance-free and gas-tight starter battery with a charging device specifically suited for this (can be purchased from specialist dealers).

Attention!

The charging current of the charging device may not exceed 5 A and the charging voltage 14.4 V. If there is a higher charging voltage, there is a danger of the starter battery exploding.

Charging the starter battery



Safety instructions

- Before starting any assembly or service work, observe the operating instructions of the riding mower and the battery charger!
- Carry out assembly and service work only with the ignition key removed and only when the motor has cooled down!
- Use the battery charger only in dry rooms!

Assembly

1. Remove the ignition key.
2. Connect the charging device to the mains and connect the terminals to the connection poles on the battery.

Pay attention to the polarity:

- red terminal = positive pole (+)
- black terminal = negative pole (-)

Accessories for battery charger CTEK XS800

46

Remove the ignition key.

47

Feed the mounting kit through the opening in the paneling.

48

Snap the connection socket firmly into the holder.

49

Connect the connecting cable to the battery.

Pay attention to the polarity:

- red terminal = positive pole (+)
- black terminal = negative pole (-)

Maintenance directives for the starter battery.

When storing for the winter, keep the starter battery in a cool, dry room (10 - 15°C).

Temperatures below freezing should be avoided during storage.

Do not leave discharged batteries uncharged for a long time.

Use a suitable charging device to charge the starter battery.

The starter battery must not:

- be stored in the immediate vicinity of naked flames
- be burnt
- or put onto radiators.

DANGER OF EXPLOSION.

Do not destroy the starter battery. The electrolyte (sulphuric acid) causes acid burns to the skin and clothes - wash off with plenty of water straight away.

Do not short circuit the connection poles.

Keep the starter battery clean. Only wipe with a dry cloth. Do not use any water, petrol, thinners or similar agents.

Keep the connection poles clean and grease them with pole grease.

Storage in winter

After the end of the mowing season, clean the device thoroughly.

Do not clean the engine with water, in particular not with a high-pressure cleaner.

Any water penetrating into the ignition unit, into the carburettor and the air filter can cause damage.

To remove dirt and residue of grass, use a cloth, a hand-held sweeper, a long-handled brush etc.

Empty the fuel tank.

Change the oil and preserve the engine - see operating instructions of the engine manufacturer.

Completely charge the battery.

Keep the machine in a dry, frost-free room. If there is a danger of frost, remove the starter battery and store it in a frost-free area.

If the starter battery remains in the machine for a longer period (longer than 1 month), remove the earth cable from the battery.

Recharge the battery after it has stood for longer than 3 months.

An inspection of the lawnmower in the winter is a benefit.

Transport of the lawn tractor

Attention!

When transporting the lawn tractor with transport equipment (e.g. a car trailer), support the mowing deck in order to relieve the Bowden cables.

Storing the lawn tractor

Attention!

The machine is to be protected against the influences of the weather, in particular moisture, rain and long periods of direct sunshine.

FAULT LOCATION PLAN

FAULT	POSSIBLE CAUSES	REMEDY
Engine does not start	Lack of fuel	Fill the tank, check the tank venting, check the fuel filter
	Bad, contaminated fuel, old fuel in the tank	Always use fresh fuel from clean containers, clean the carburettor (workshop)
	Air filter contaminated	Clean the air filter (see operating instructions for the engine)
	No ignition spark	Clean the spark plug, possibly replace. Check ignition cable. Check ignition unit = authorised service agent
	Engine "flooded" due to repeated attempts to start	Unscrew spark plug and dry off.
Starter does not react	Starter battery empty or weak	Charge starter battery
	Safety switch on driver's seat not functioning	Sit on the driver's seat correctly
	Safety switch on brake pedal not functioning	Press the brake pedal right down
	Mowing appliance switched on	Switch the mowing appliance off
	Fuse (5A) on (+) cable of the starter battery	Check
Engine performance drops	Grass too long or too wet	Correct the cutting height. Create air flow by briefly moving backwards
	Discharge channel/mowing deck blocked	Clean discharge channel/mowing deck. Switch the engine off and remove the spark plug connector.
	Air filter contaminated	Clean the air filter (see engine information)
	Carburettor setting wrong	Have the setting checked - authorised service agent
	Blade severely worn	Replace blade - Only use original replacement blade - authorised service agent
	Speed too high	Reduce speed
Lawn tractor does not move	With hydrostat drive: No traction	Move bypass lever to operating position [see driving without traction (pushing)].
Poor cut	Blade worn, blunt	Replace or regrind blade. Balance reground blades. Only use original replacement blade - authorised service agent
	Incorrect cutting height	Alter cutting height
	Engine speed too low	Set engine speed to Max.
	Speed too high	Reduce speed
	Differing tyre pressure on wheels	Pump up to correct air pressure. Tyre pressure: see technical data
Grass box not filling	Mower setting too low;	Adjust cutting height
	Grass is too damp and too heavy to be transported by the air flow	Wait until the lawn has dried off
	Blade badly worn	Replace blade. Only use original replacement blade - authorised service agent
	Grass too long	Cut the lawn twice: 1st cut: max. cutting height 2nd cut: required cutting height
	Fabric sack blocked - no air flow	Clean the fabric sack
	Discharge channel of mowing deck blocked - last cuttings	Clean the discharge channel/mowing deck
Level display does not react	Cuttings on level display lever	Remove cuttings from level display lever - check for each of movement
Drive, brakes, clutch and mowing appliance	have a regular check done by the authorised service agent.	



Electrical repairs may only be carried out by a qualified electrician or service agent.

GUARANTEE

During the legal guarantee period, we will remedy any faults due to faulty materials or manufacture at our discretion by repair or by the supply of spare parts.

The guarantee period is subject to the current law of the country in which the machine was purchased.

The guarantee is only valid under the following conditions:

The machine has been treated properly.
The operation instructions have been followed.
Genuine spare parts have been used.

The guarantee is void if:

Attempts have been made to repair the machine.
The machine has been altered.
The machine has been used incorrectly, (e.g. commercial or communal use etc.).

The following items are excluded from the guarantee:

Paint damage due to normal wear.

Wearing parts on the spare parts card which are marked with the box **XXX XXX (X)**

Internal combustion engines - separate guarantee conditions apply to these from the relevant engine manufacturer.

In the event of a claim under the guarantee, please contact your dealer or the nearest authorised customer service centre with this guarantee declaration and a proof of purchase.

The legal guarantee rights of the purchaser in respect of the seller remain unaffected by the terms of this guarantee.